

[Home](#) / [Browse jobs](#)



RAN Huawei Expert

Found in: beBee jobs IQ - 7 days ago

Apply

Erbil, Erbil, Iraq KOREK Telecom Ltd. Full time

Number of Positions 1 **Experience** 5-10 years of work experience in relevant field. **Education** Bachelor in Telecommunication, Electrical or Electronic Engineering. **Location** Erbil

Summary

Supervise and work on the Huawei Swap project in KRG Region and work on the Huawei network to have a stabile network performance and achive targeted KPIs.

Key Responsibilities

End to End, Radio Design for 2G/3G/4G/5G.

Set RF Division action plans and KPI targets for 2G, 3G, 4G ,5G Do Passive/Active IBS Design on Planning tools Identify and anticipate network performance issues.

Provide recommendations for improvement and do network resource and license dimension plan. Determine the coverage, quality and capacity requirements for every region/area. Set recommendations to resolve problems and Adding/Expanding Sites/Licenses Perform RF planning (using Atoll), traffic planning, and traffic growth forecasting. Interface with vendor support for all related issues of radio planning and pptimization.

Strategic planning for all required equipment from the radio perspective Optimize the capacity of the network to meet traffic increase.

Ensure that design & optimization guarantees the capability for the network to provide end-user new services. Secure the competence transfer to local staff. End to End, Radio Optimization for 2G/3G/4G/5G. Pre-Optimization Features/Parameters Analysis. Perform physical and soft parameter planning. Identify and anticipate network performance issues and provide recommendations for improvement. Optimize the capacity of the network to meet traffic increase. Ensure that design & optimization guarantees the capability for the network to provide end-user new services.

Competencies

Competence in KPI Counters and Root Cause analysis and Problem solving 3G/4G/5G network.

Proven ability of optimizing and design UMTS/LTE/5G networks at a single NodeB, cluster and multi-cluster levels for multiple carriers to meet specific KPI targets.

Good team player & analytical skills Experience in UMTS/LTE/5G networks and KPI base system optimization. Strong knowledge on RF Optimization tools. Good knowledge of RF design method and procedure. Ability to Work with Planning Tools (Atoll, IBwave) is preferred. Ability to present workshops regarding LTE Radio Network requirements. Must have experience in Ericsson and Nokia, and preferably, in Huawei equipment.

Language

English (required) Kurdish (required)* Arabic (preferred)

[Report this job](#)

Apply



RAN Huawei Expert

Found in: beBee S IQ - 7 days ago

erbil, Iraq KOREK Telecom Ltd. Full time



M Zeeshan

Wireless Product Manager at Huawei Technolo...

More

Message

← Projects

Jordan Ummiah 5G SA/NSA Radio Project 2022-2023

Oct 2022 - Present



Associated with Huawei

- > On-site Project Support on Invitation of Jordan Rep Office in Open Bidding.
- > Preparation of HLD, LLD, BOQ, Technical Proposal and Commercials as per customer RFP.
- > Configuration of Quotation for Huawei Licenses (Hardware Licenses, Feature Licenses and Huawei Value added Software Features etc.).
- > Existing Network Analysis for Hardware Capability.
- > Solution Presentation, Negotiation and Clarification to customer.
- > Solution alignment with internal Service and Delivery team.

Skills: High-Level Design · Technical Proposal Writing · Wireless Network Design · Target Network Design · Presentation to Customer, Solution Guidance · Low-Level Design · Network Insight, Traffic Forecast and Proposing Huawei Solution.

Iraq Zain Capex 2020-2023

Sep 2020 - Present



Associated with Huawei

- Preparation of HLD, LLD, Internal BOQs and Customer BOQs.
- > Existing Network Analysis for Capability requirement for Network Modernization.
- > Solution Clarification with customer.

Skills: High-Level Design · Technical Proposal Writing · Wireless Network Design · Target Network Design · Presentation to Customer, Solution Guidance · Low-Level Design · Network Insight, Traffic Forecast and Proposing Huawei Solution.

Iraq Korek Swap Project 2023

Sep 2020 - Dec 2022



Associated with Huawei

- > Preparation of Internal Bill of Quotation(BOQs) and Commercial Design as per customer RFX.
- > Preparation of Internal Meetings Material (Project Background, Customer Pain Points etc.).

Skills: High-Level Design · Technical Proposal Writing · Wireless Network Design · Target Network Design · Presentation to Customer, Solution Guidance · Low-Level Design · Network Insight, Traffic Forecast and Proposing Huawei Solution.

Iraq Ooredoo Asiacell CR3.0

Dec 2021 - May 2022



Associated with Huawei

- > Preparation of HLD, Technical Proposal and BOQs as per customer RFP.
- > Customer Meetings to align the Solution and Clarifications.

Skills: High-Level Design · Technical Proposal Writing · Wireless Network Design · Target Network Design · Presentation to Customer, Solution Guidance · Low-Level Design · Network Insight, Traffic Forecast and Proposing Huawei Solution.

Pakistan Ufone 5-Years RFP Network Expansion and New Rollout 2022-2026

Sep 2021 - Jan 2022



Associated with Huawei

- > Preparation of Internal Bill of Quotation(BOQs)

This material is distributed by Quinn Emanuel Urquhart & Sullivan, LLP on behalf of Agility Public Warehousing Company KSCP. Additional information is available at the Department of Justice, Washington, DC.

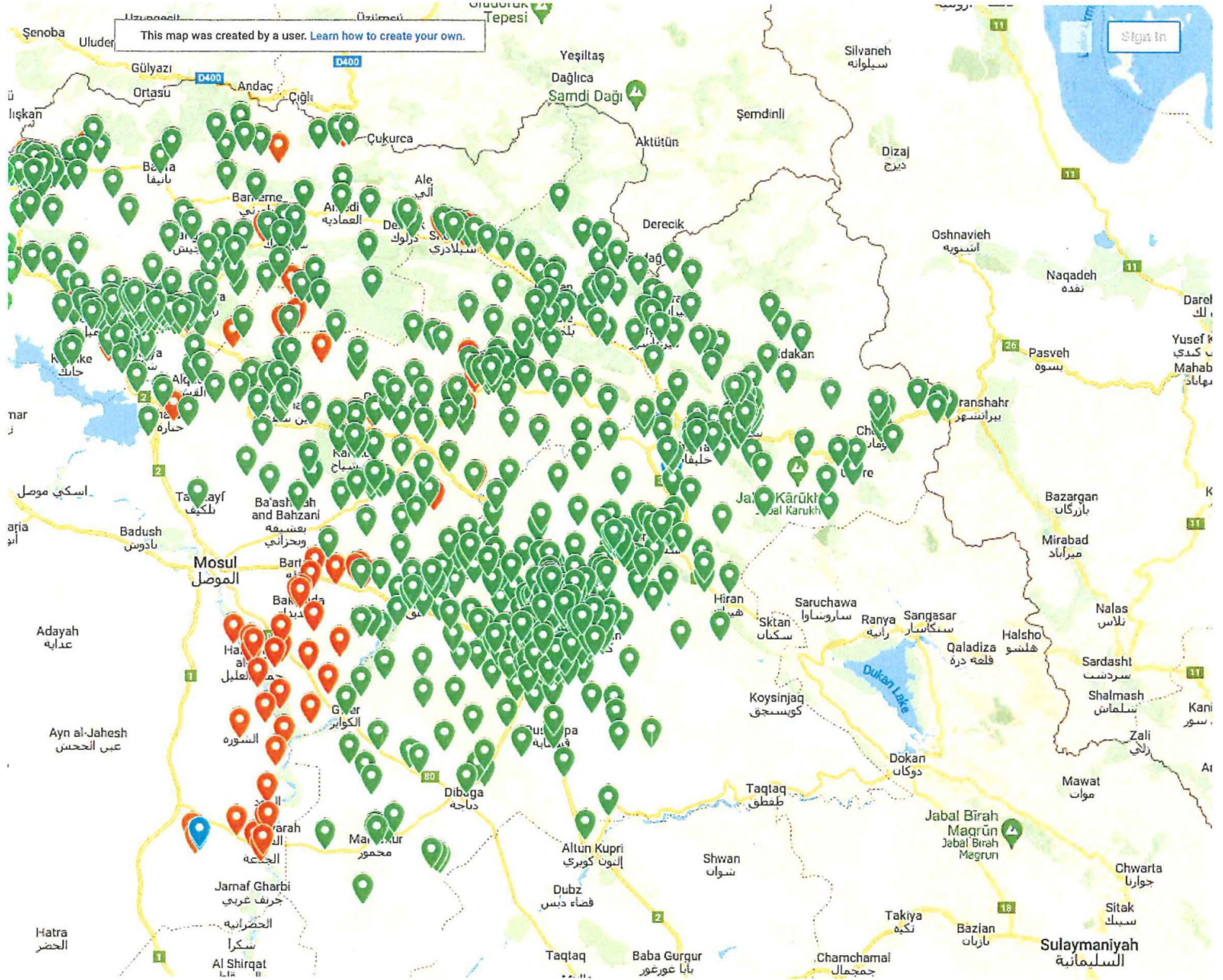

This material is distributed by Quinn Emanuel Urquhart & Sullivan, LLP on behalf of Agility Public Warehousing Company KSCP. Additional information is available at the Department of Justice, Washington, DC.

Contact

www.linkedin.com/in/m-zeeshan-61177815b (LinkedIn)

Top Skills

Commercial Management
Customer Experience
Request for Proposal (RFP)

Languages

M Zeeshan

Wireless Product Manager at Huawei Technologies STC Account

Summary

4+ Years of experience as Wireless Product Manager at Huawei Technologies which includes but not limited to Technical Sales Business support for multiple Operators in the Middle East Region.

Experience

Huawei

5 years 2 months

Product Manager

February 2024 - Present (11 months)

Acting as the Wireless Product Manager towards Saudi Telecommunication Company (STC)

> To achieve company goals, generate leads and sales by presenting our solutions to STC, convincingly answering questions and creating a clear vision of our products.

> As frontline, to ensure smooth solution implementation by aligning STC requirements with RF team for RF Planning and predictions, mitigating risks with HQ experts, managing the supply chain, coordinating delivery and implementation.

> Supporting Huawei account team in commercial negotiations with STC Procurement team.

> Develop a customized wireless solution aligned to the STC network needs, providing them with an optimal technical and commercial proposal by making HLD, Technical Proposal, Commercial Proposal (BOQ).

> Explore STC pain points by analyzing market potential, competition landscape, network pain points, Huawei's new solutions, and industry trends, and seek Huawei's breakthrough points

This material is distributed by Quinn Emanuel Urquhart & Sullivan, LLP on behalf of Agility Public Warehousing Company KSCP. Additional information is available at the Department of Justice, Washington, DC.

- > Understand STC network problems (performance, development, O&M, and business) and operation issues (market development, competition issues, CAPEX (capital expenditure)/OPEX (operating expense), internal management, and operation efficiency)
- > Live Network Analysis, Network Insights to visualize the Current Network picture to customer and presenting the Huawei solutions to optimize their network
- > Participate in customer relationship development

Wireless Product Manager

April 2020 - February 2024 (3 years 11 months)

Islamabad, Pakistan

Acting as the Wireless Product Manager for Middle East Region Operators to Demonstrate Huawei's capabilities to customers and stimulate customer's interests.

Key Responsibilities:

- > Leading the project, From Lead to Contract
- > Solution Design and Product Selection.
- > Analyze project background and output materials HLD, LLD, Technical Proposal and BOQ Configuration till PO Registration as per Huawei Digital Transaction Process .
- > Solution Presentation to customer.
- > Live Network Analysis and Target Network Design.
- > Customer Negotiation and Solution Clarification.

Wireless Network Design

November 2019 - April 2020 (6 months)

Islamabad Pakistan

Acting as the Wireless Network Design Engineer

Key Responsibilities:

- > Bill of Quotation and HLD for Wireless Product with RTUs and Software Features.
- > Contracts Publishing as per transaction flow operations from lead to cash as per Digitalization Process.

National Centre for Physics

Micro-controllers Programmer

January 2019 - April 2019 (4 months)

Islāmābād, Pakistan

Three Months Internship included the Python Programming and several microcontroller projects.

Key Responsibilities:

- > Microcontrollers Programming mainly for Arduino
- > Sensors and Actuators Interfacing for Digital Displays
- > Python Programming for Basic Functions of Simulations
- > Simulation on Matlab and Proteus Professional.

National Institute of Electronics

Development of Robotics by Programming

June 2017 - August 2017 (3 months)

Islāmābād, Pakistan

Internship Provided by Govt of Pakistan during the Graduation to Orient the University Projects into Industry level. Key Responsibilities:

- > Designing of Robotics to perform different functions.
- > Microcontrollers Programming mainly on Atmel and PIC
- > Controlling Inverters, Motors and Relays etc by using Sensors.
- > Projects Report Preparation and Presentation to the board.

Education

Preston University

BS, Electronics · (2015 - 2019)

Installation Solution

Network modernization Project

Prepared by :
Ibrahim Dia
Zaheer Yousuf

Operator



This material is distributed by Quinn Emanuel Urquhart & Sullivan, LLP on behalf of Agility Public Warehousing Company KSC. Additional information is available at the Department of Justice, Washington DC.





No CR No Work!

- Enter and leave site, must call MS NOC
- Hot Line:
BSS: 0750 4450015

Network Safety

























- 1- Any change operation on the live network solution should be executed strictly according to the Down time approved by customer
- 2- Do not accept any temporary un-planned change operation arrangement
- 3- Any extra operation out of the change solution is prohibited
- 4- There must be another engineer to confirm the each step operation during the important change
- 5- Any incident must report to the product line team leader and CS Manger
- 6- Confirm all service are running well with the monitor center before the leave

No CR No Work! Call Customer NOC before enter or after leave site!
Any unclear issue call BO!



Preparations

Prepare tools and cables required for installing the Outdoor Power Cabinet . Choose cables that comply with electrical specifications and ensure that cable colors meet local power cable standards .

 Paper knife	 Marker pen	 Rubber hammer	 Phillips screwdriver	 Flathead screwdriver
 Combination spanner	 Adjustable spanner	 Torque spanner	 Socket spanner	 Diagonal plier
 Wire clippers	 Power cable cutting pliers	 Power cable crimping pliers	 Hydraulic pliers	 Wire stripper
 Percussion drill	 Drill bit	 Clamp meter	 Hot air gun	 ESD-preventive wrist strap
 Vacuum cleaner	 Ladder	 Antistatic gloves	 Protective gloves	 Steel tape

TOOL004



Safety Precautions

- **General Safety Precautions**

- This product should be used in the environment that meets design specifications. Otherwise, the product may be damaged, and the resulting product exceptions or component damage are beyond the warranty scope.
- Only trained and qualified personnel are allowed to install, operate, and maintain Huawei equipment.
- Comply with local laws and regulations. The safety instructions in this document are only supplements to the local laws and regulations.
- Do not operate the device or cables during lightning strikes.
- Remove metal objects such as the watch, bracelet, or ring during operations.
- Use insulated tools during operations.
- During installation and maintenance, follow the specified procedure.
- Before you touch any conductor surface or terminal, use an electric meter to measure the contact point voltage. Ensure that the contact point has no voltage or the voltage is within the specified range. If the power system is not connected to batteries or the battery capacity is insufficient, the load may power off during maintenance or fault locating.
- After device installation, perform routine check and maintenance according to the user manual and replace faulty components in a timely manner to ensure secure device running.



Huawei Equipment Description

- RRU :Remote radio unit .
- BBU: Baseband unit .
- UMPT :Universal main processing and transmission unit
- UBBP :Universal baseband processing unit .
- UPEU :Universal power and environment interface unit .
- DCDCU : Direct current distribution unit .
- SLPU : Signal lightning protection unit .
- RTN : Radio transmission node
- AISG : Antenna Interface Standards Group
- UIM05B1 : User Interface Module



Huawei Cabinet type

- **Outdoor Single Cabinet:** Access sites will install one outdoor cabinet for battery and telecom Equipment .



Cabinet Specification

- Dimension (W × D × H): Cabinet: 750mm × 750mm × 2000mm (excluding base)
- Base: 750mm × 750mm × 150mm
- Use for Battery & Telecom installation .
- User space :18U and 2 Sets of Battery
- LLVD branch :2 × 125A MCB, 3 × 63A MCB
- BLVD branch: 2 × 63A MCB, 2 × 32A MCB, 2 × 16A MCB

**Outdoor Battery & Telecom cabinet
MTS9514A-AM2001**

BBU5900 Slot and CPRI Port



BBU5900 slots (half-width)

Fan	Slot0 → Slot1	UPEU
	Slot2 → Slot3	
	Slot4 → Slot5	UPEU
	Slot6(MPT) Slot7(MPT)	

Normal 3 sector scenario BBU Layout:

CPRI connection

Default: for 3 sectors
 900M RRU: Slot2- Port 0/1/2
 1800/2100 RRU: Slot4-0/1/2

NEW BBU 5900

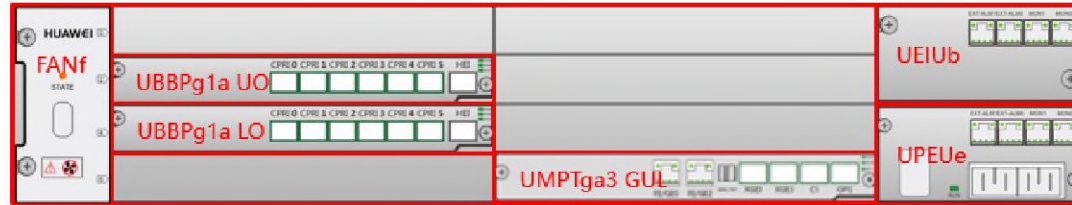

BBU5900-0-0

4 sector scenario BB Layout:

CPRI connection

900M RRU: Slot2- Port 0/1/2/3
 1800/2100 RRU: Slot4-Port 0/1/2/3

NEW BBU 5900

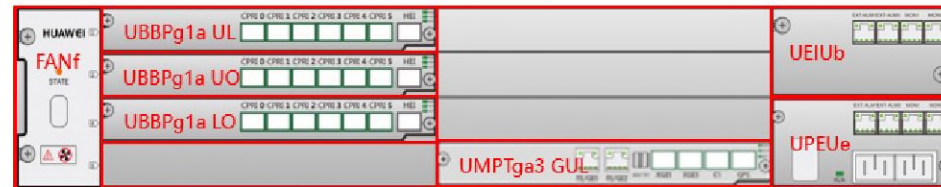

BBU5900-0-0

BBU Boards

Connect to
Transmission fiber port

Figure 4 UMPTg panel

UMPTga3

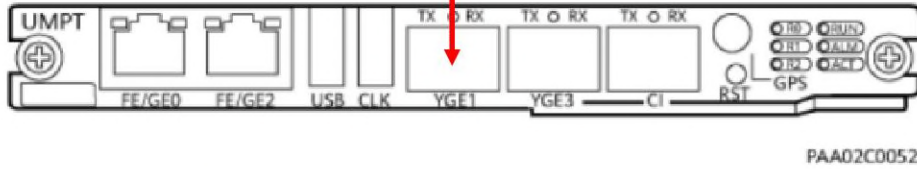

Connect for RRU CPRI Fiber

UBBPg1a

Figure 9 UBBPg panel

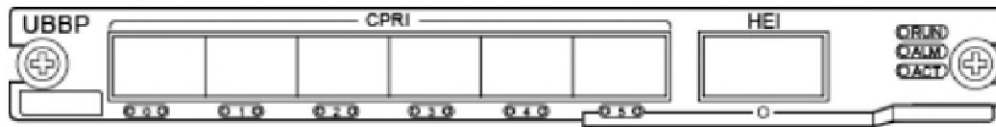

Connect for External Alarm

UPEU

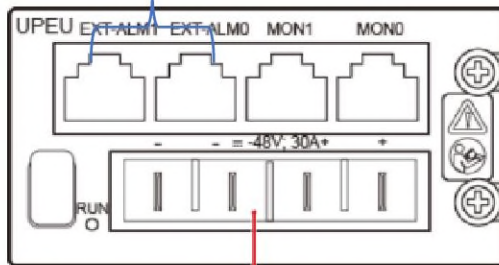

Connect for BBU Power Cable



UMPTga3 Description

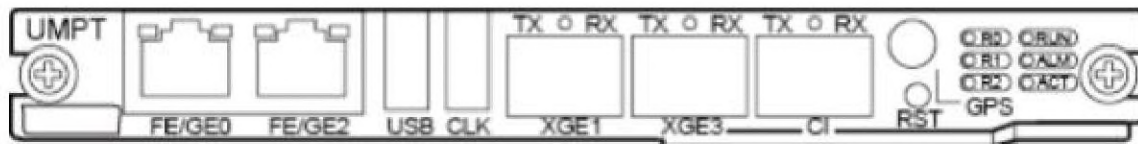

Board	Single-RAT	Multi-RAT		
UMPTga1/UMPTga2/UMPTga3	GSM/UMTS/LTE FDD/LTE NB-IoT/LTE TDD/NR FDD/NR TDD	Co-MPT multiple modes		
I	Number of GSM carriers			
Board	Number of Carriers			
UMPTga1/UMPTga2/UMPTga3	72			
I	Transmission port specifications			
Board	Transmission Mode	Port Quantity	Port Capacity	Full-/Half-Duplex
UMPTga3	FE/GE/10GE optical transmission	2	100/1000/10000 Mbit/s	Full-duplex
I	LTE FDD specifications			
Board	Number of UEs in RRC_CONNECTED Mode	Number of UL-sync UEs	Number of DRBs	Signaling Specifications (BHCA)
UMPTga1/UMPTga2/UMPTga3	14400	14400	43200	1620000
I	LTE TDD specifications			
Board	Number of UEs in RRC_CONNECTED Mode	Number of UL-sync UEs	Number of DRBs	Signaling Specifications (BHCA)
UMPTga1/UMPTga2/UMPTga3	14400	14400	43200	1620000



UBBq1a Description

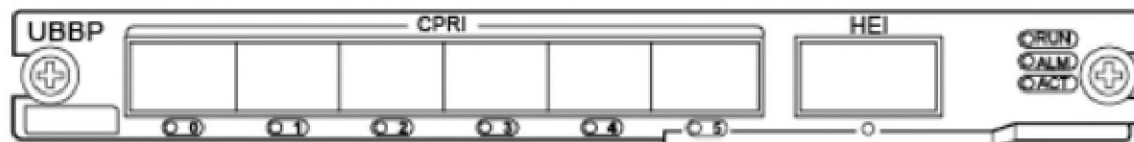

Board	Silkscreen	Connector	Port Quantity	Description
UBBPd/UBBPe/UBBPg1/UBBPg1a/UBBPg2/UBBPg2a/UBBPg3b/UBBPg3/UBBPf3	CPRI: 0–5	SFP female connector	6	They are data transmission ports connecting the BBU to RF modules, and support input and output of optical and electrical signals.
	HEI	QSFP connector	1	The port connects a baseband processing unit and a universal switching unit (USU) to exchange signals between them.

RRU Module

RRU5909(900M)

Item	Specifications
Dimensions (H x W x D)	400 mm x 300 mm x 100 mm (15.75 in. x 11.81 in. x 3.94 in.) (12 L)
Weight	15 kg (33.08 lb, excluding mounting kits)
TX/RX	2T2R, 2*60W

RRU5502(1800/2100M)

Item	Specifications
Dimensions (H x W x D)	480 mm x 356 mm x 140 mm (18.90 in. x 14.02 in. x 5.51 in.) (24 L)
Weight	25 kg (55.13 lb, excluding mounting kits)
TX/RX	4T4R, 4*80W

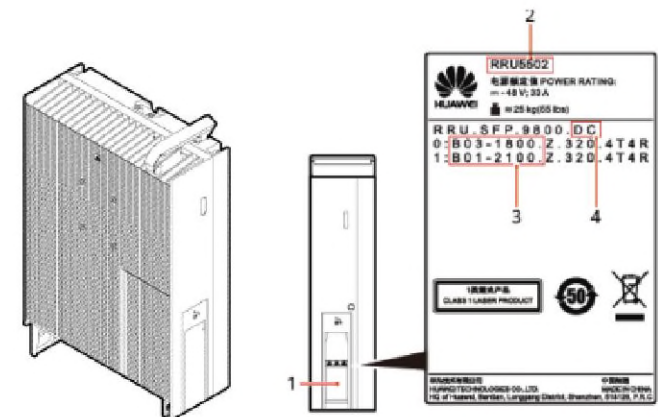
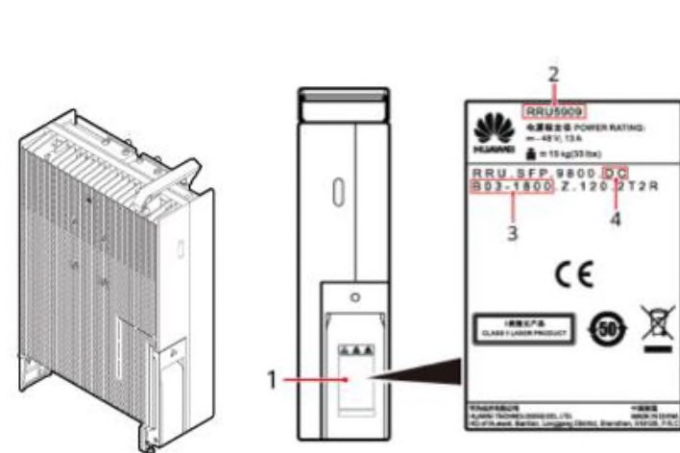

RRU Module

RRU5513(1800/2100)

Item	Specifications
Dimensions (H x W x D)	480 mm x 356 mm x 140 mm (18.90 in. x 14.02 in. x 5.51 in.) (24 L)
Weight	25 kg (55.13 lb, excluding mounting kits)
TX/RX	4T4R, 4*100W

RRU5910(900)

Item	Specifications
Dimensions (H x W x D)	400 mm x 300 mm x 150 mm (15.75 in. x 11.81 in. x 5.91 in.) (18 L)
Weight	22 kg (48.51 lb, excluding mounting kits)
TX/RX	4T4R, 4*60W

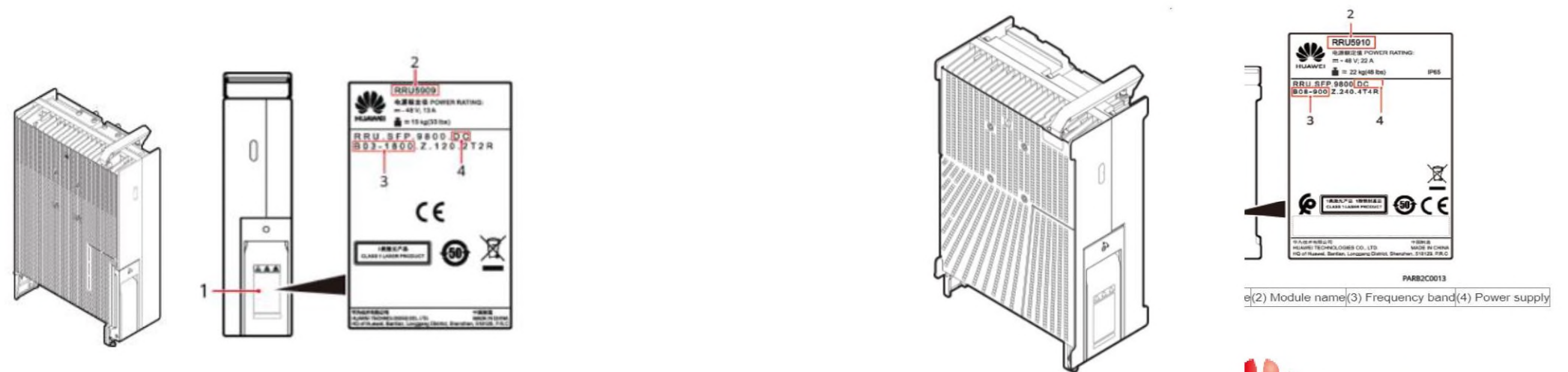

RRU Ports

RRU5909(900M)

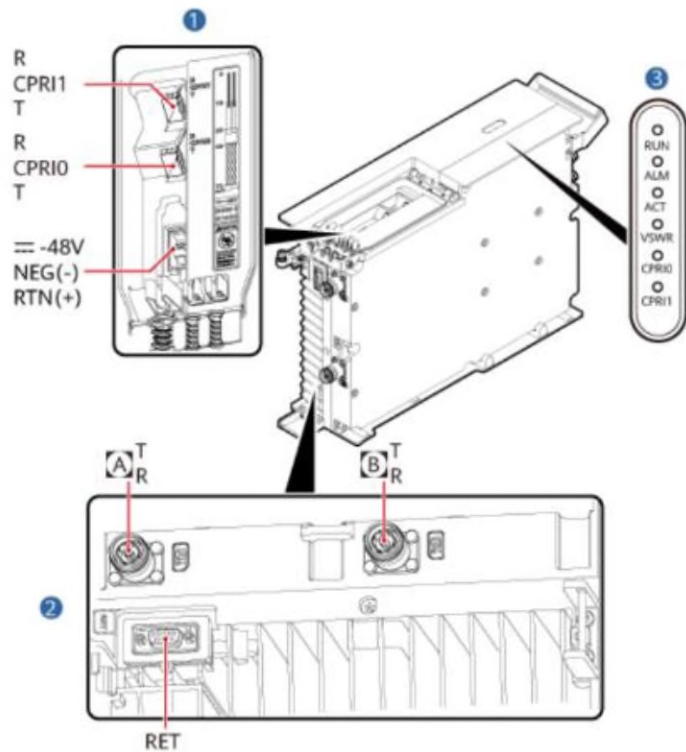

RRU5502(1800/2100M)

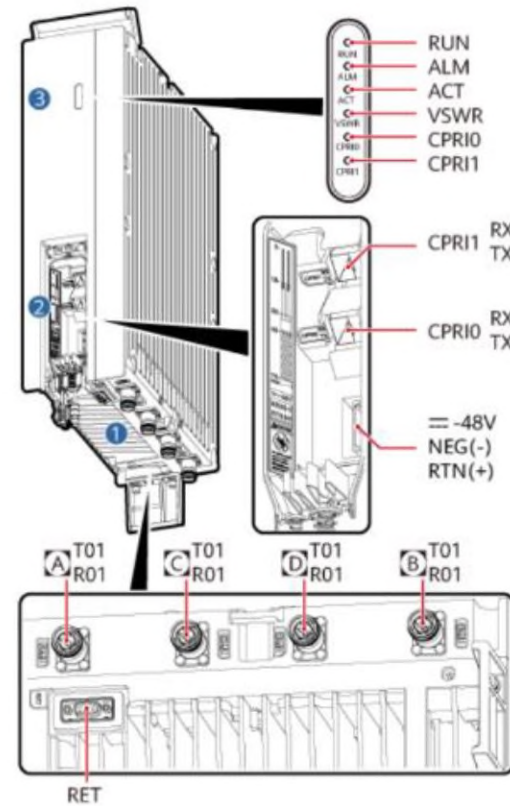

RRU Ports

RRU5910(900M)

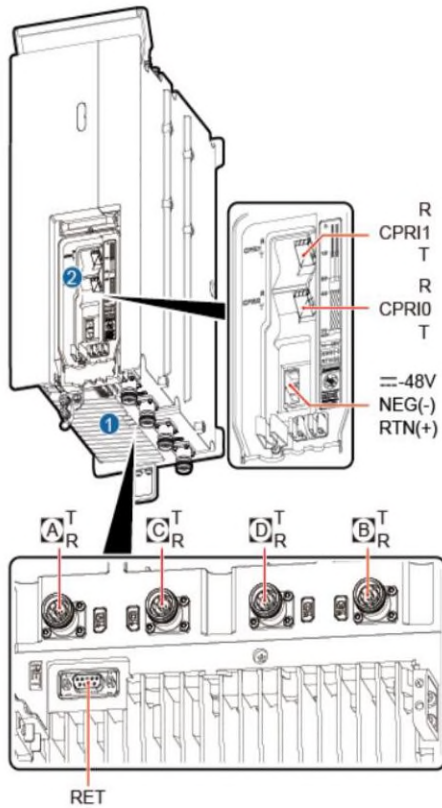

RRU5513(1800/2100M)

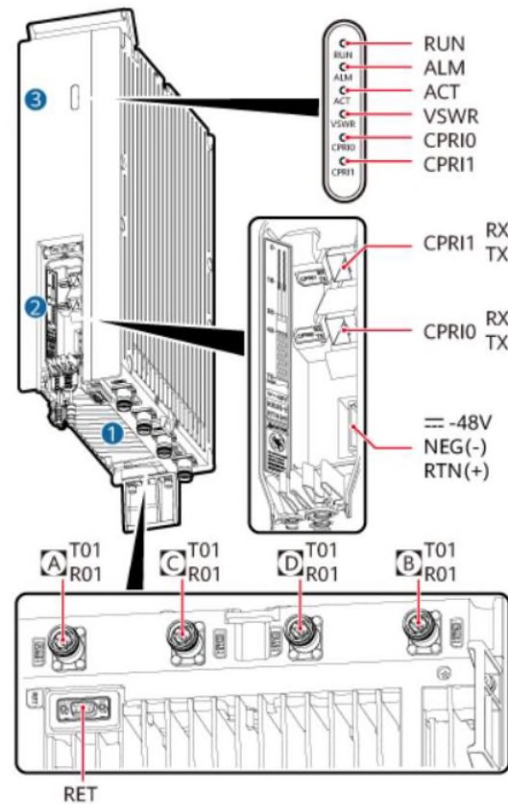

RRU Fiber Cable And SFP Module

RRU CPRI Fiber

Figure 1 Exterior of the dual-core optical fiber with DLC connectors



CPRI Label on the Breakout Cable	Connection Between a BBU and an RRU(Recommend)
1A	CPRI RX port on the RRU
1B	CPRI TX port on the RRU
2A	CPRI TX port on the BBU
2B	CPRI RX port on the BBU

RRU/BBU SFP Module

An optical module transmits optical signals between an optical port and an optical fiber.

Optical modules can be classified into single-mode and multimode optical modules, which can be distinguished as follows:

- The puller of a single-mode optical module is blue and the puller of a multimode optical module is black or gray.
- The transmission mode is displayed as "SM" on the label of a single-mode optical module and "MM" on the label of a multimode optical module.

Optical modules must be used in pairs on both ends of an optical fiber.

SFP duplex (two-fiber bidirectional, duplex for short) optical module.

There is a label on each optical module, which provides information such as the rate, wavelength, and transmission mode, as shown in the following figure.

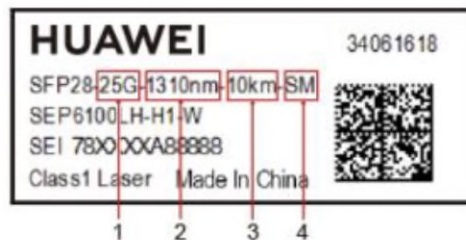
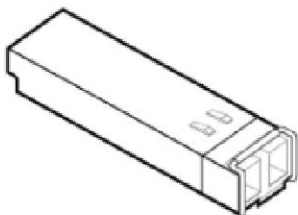

Note:
RRU SFP will be 9.8G(10G) Single Mode

- (1) Rate
- (2) Wavelength
- (3) Transmission distance
- (4) Transmission Mode



RRU Jumper and AISG Cables

RRU5909/RRU5502/RRU5513/RRU5910

RRU Jumper Cable

For an RF jumper, one end is a 4.3-10 male connector to connect to RRU, and the other end is connected to a connector based on antenna port requirements, which is a 4.3-10 male connector or DIN male connector.

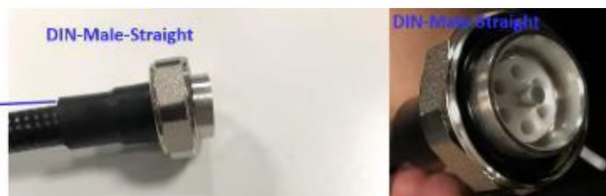
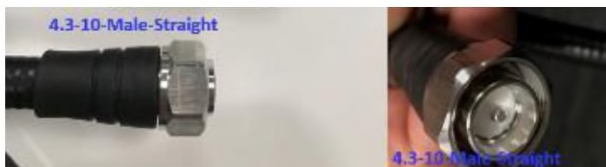

DIN and 4.3-10 female connector example

RRU RET AISG Cable

An AISG multi-wire cable has a waterproof DB9 male connector at one end and a standard AISG female connector at the other end:

(1) Waterproofed DB9 male connector

Figure 1 AISG multi-wire cable (1)

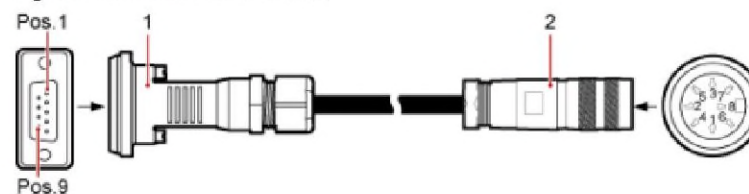

Figure 2 AISG multi-wire cable (2)



RRU RET AISG Extension Cable



(1) AISG standard male connector (2) AISG standard female connector



Site Scenarios

- **Scenario 1 GU900 (RRU5909 ,S111) + GL1800/UL2100(RRU5502, S111)**
- **Scenario 2 GU900(RRU5909, S111) + GL1800/UL2100(RRU5513, S111)**
- **Scenario 3 GU900(RRU5910 , S111) + GL1800/UL2100(RRU5513, S111)**



Scenario 1 :GU900(RRU5909)+GL1800/UL2100(RRU5502) New Antenna(3 Sector)

BBU and RRU CPRI Connection

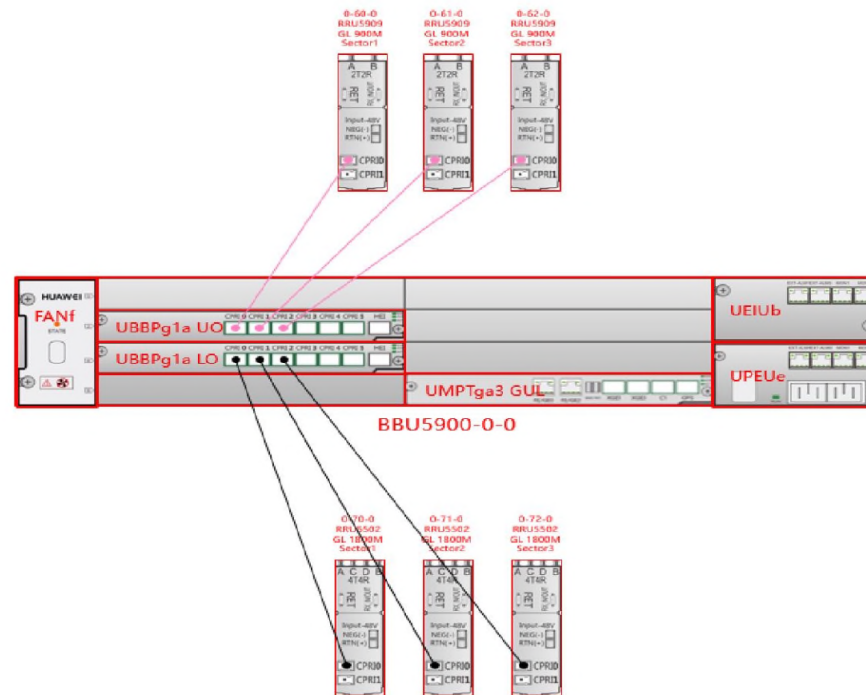

Description of work :

- Install New BBU5900+1*UMPTga3;
- Install 2*UBBPg1a;
- Connect BBU Power cable on DCDU
- Connect BBU Fiber and SFP to Transmission Device
- Connect BBU EXT Alarm Cable from UPEU to DDF(external alarm box)
- Dismantle E// BBU and Cabinet and antenna after Swap finish



Scenario 2: GU900(RRU5909)+GL1800/UL2100(RRU5513) New Antenna(3 Sector)

BBU and RRU CPRI Connection

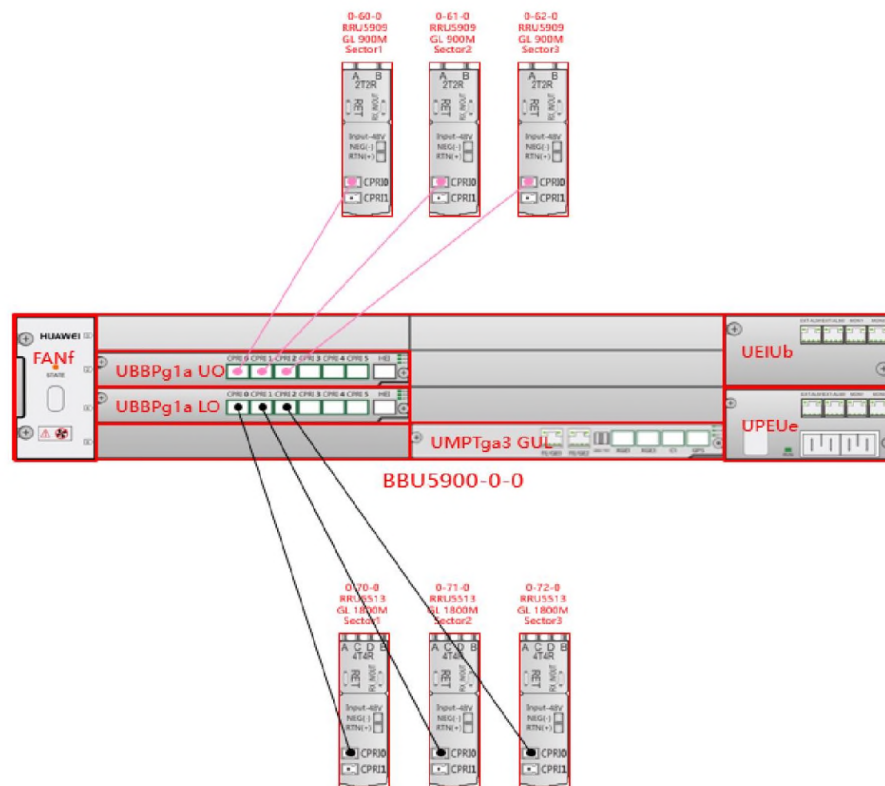

Description of work :

- Install New BBU5900+1*UMPTga3;
- Install 2*UBBPg1a;
- Connect BBU Power cable on DCDU
- Connect BBU Fiber and SFP to Transmission Device
- Connect BBU EXT Alarm Cable from UPEU to DDF(external alarm box)

- Dismantle E// BBU and Cabinet and antenna after Swap finish



Scenario 3: GU900(RRU5910)+GL1800/UL2100(RRU5513) New Antenna(3 Sector)

BBU and RRU CPRI Connection

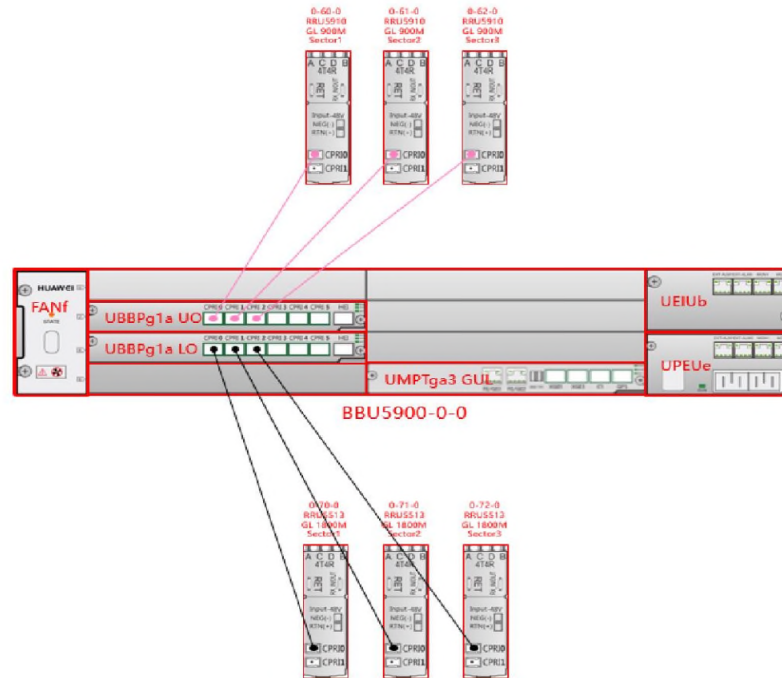

Description of work :

- Install New BBU5900+1*UMPTga3;
- Install 2*UBBPg1a;
- Connect BBU Power cable on DCDU
- Connect BBU Fiber and SFP to Transmission Device
- Connect BBU EXT Alarm Cable from UPEU to DDF(external alarm box)

- Dismantle E// BBU and Cabinet and antenna after Swap finish



Fourth sectors Connection Solution :

The 4th Sector will connect to Port3 of UBBPg1a boards

Description of work :

- Install New BBU5900+1*UMPTga3;
- Install 3*UBBPg1a;
- Connect BBU Power cable on DCDC
- Connect BBU Fiber and SFP to Transmission Device
- Connect BBU EXT Alarm Cable from UPEU to DDF(external alarm box)
- Dismantle E// BBU and Cabinet and antenna after Swap finish

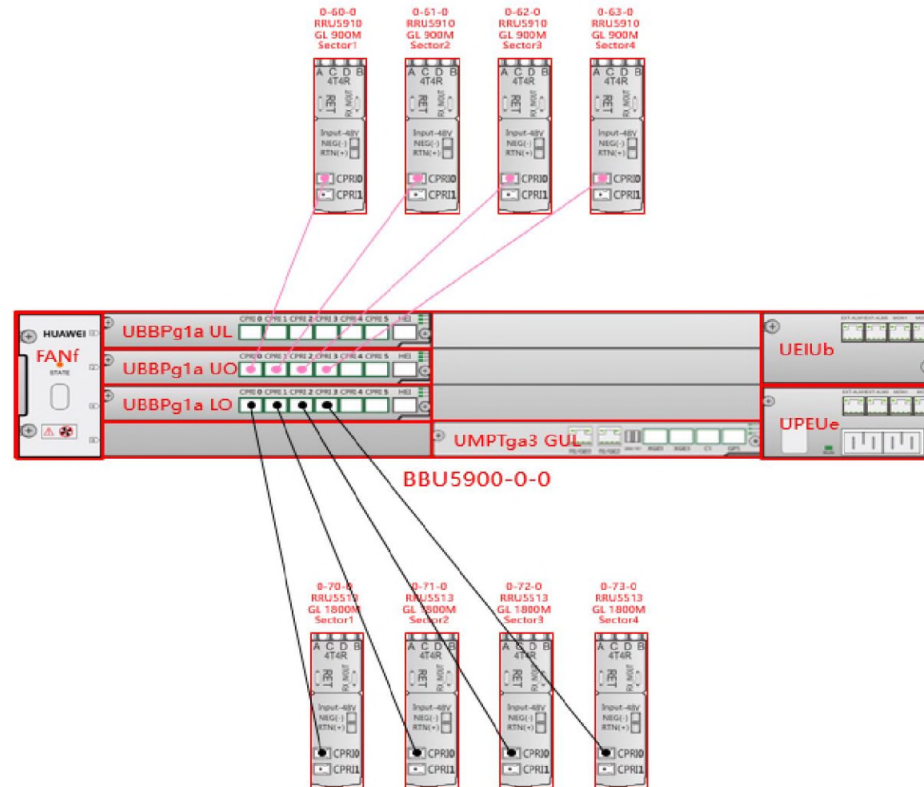

If there are only two Sectors on site so need to install
Only One UBBPg1a on Site "Slot4 :



Received by NSD/FARA Registration Unit 06/05/2025 8:02:33 PM

Standard For Site Scripting

For RRU

900 RRUs = 60, 61, 62, 63

For GL 1800 + 2100 = 70, 71, 72, 73

For RRU Chain

900 RRUs = 0, 1, 2, 3

GL 1800 + 2100 = 20, 21, 22, 23

For Sector

900 = 0, 1, 2, 3

For 1800 + 2100 = 20, 21, 22, 23

For Sector Eqm

G900 = 0, 2, 4, 6

U900 = 10, 11, 12, 13

G1800 = 20 & 21, 22 & 23, 24 & 25, 26 & 27

U2100 = 30, 31, 32, 33

L1800 = 40, 41, 42, 43

L2100 = 50, 51, 52, 53





Antenna Jumpers & AISG cable connection Layout

- G900+G1800+U900+L1800+L2100

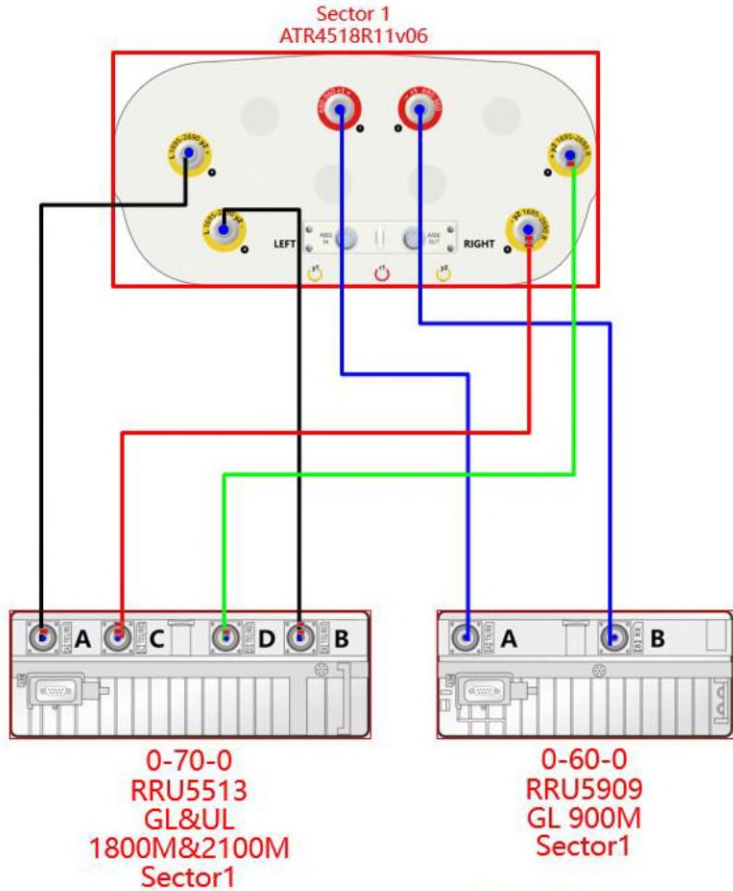

Port and Array Layout

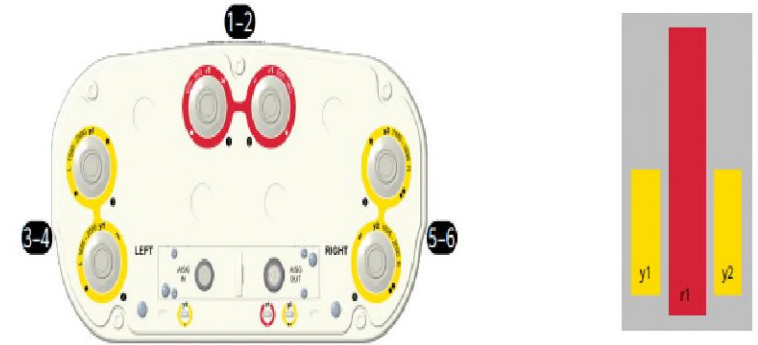

L: Left array R: Right array r: Red y: Yellow

Port	Array	Freq(MHz)	RET S/N
1-2	r1	690-960	HWxxxxx.....r1
3-4	Ly1	1695-2690	HWxxxxx.....Ly1
5-6	Ry2	1695-2690	HWxxxxx.....Ry2



Antenna Jumpers & AISG cable connection Layout

- G900+G1800+U900+L1800+L2100

AQU4518R25v18

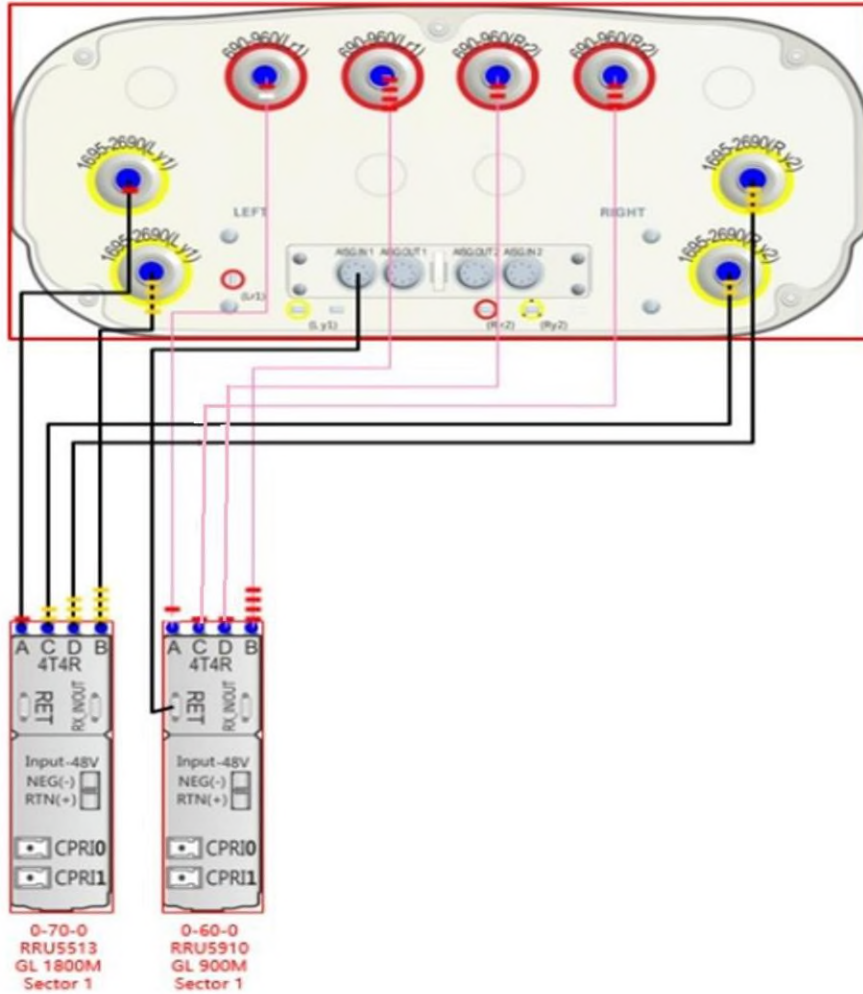

Port and Array Layout

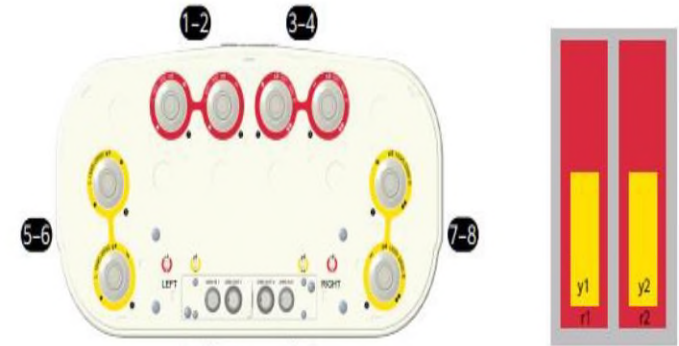

Port	Array	Freq(MHz)	RET S/N
1-2	Lr1	690-960	HWxxxx...Lr1
3-4	Rr2	690-960	HWxxxx...Rr2
5-6	Ly1	1695-2690	HWxxxx...Ly1
7-8	Ry2	1695-2690	HWxxxx...Ry2



Outdoor cabinet MTS9514A Circuit Breaker Design

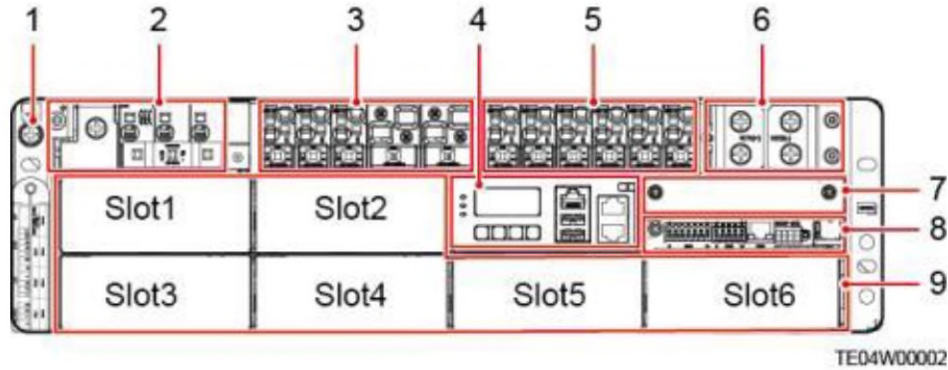

- (1) Ground screw
- (2) AC input module
- (3) LLVD power distribution
- (4) SMU02C
- (5) BLVD power distribution
- (6) Battery wiring ports
- (7) Reserved slot for CIM02C/NIM01C3
- (8) UIM05B1
- (9) Space for rectifiers

HUAWEI Cabinet MTS9514A Breaker											
LLVD					BLVD						
1	2	3	4	5	7	8	9	10	11	12	
125A	125A	63A	63A	63A	63A	63A	32A	32A	16A	16A	
DUDU16D-02	DUDU16D-02	DCDU-12B	DCDU-12B	1*RRU5513(RRU5502)	RTN-1	RTN-2	RTN-1	RTN-2	ATN-1	ATN-2	

Outdoor cabinet MTS9514A Circuit Breaker Design

BLVD	
1*RTN1	2*63A
1*RTN2	2*32A
1*ATN	2*16A

LLVD		LOAD	Item	Description		
3*5513(5502)	53.31	2*125A	DUDU16D-02	LOAD0 to LOAD2	25030695	Electronic Electric Cable,450V/750V,H07Z-K UL3386,25mm^2,Blue,138A,LSZH Cable,VDE,UL
BBU	25.45			LOAD3 to LOAD4	25030638	Electronic Electric Cable,450V/750V,H07Z-K UL3386,25mm^2,Black,138A,LSZH Cable,VDE,UL
Total	78.76					
4*RRU5910(5909)	44.4	2*63	DUDU-12B	LOAD0 to LOAD3	25030428	Electronic Electric Cable,450V/750V,60227 IEC 02(RV),16mm^2,Black,85A,CCC,CE
					25030430	Electronic Electric Cable,450V/750V,60227 IEC 02(RV),16mm^2,Blue,85A,CCC,CE
1*5513(5502)	17.7	1*63	Direct to rectifier			



Power Cable Connection Size

Connection	Item	Decirption
between DCD16D-02 and Rectifier	25030695	Electronic Electric Cable,450V/750V,H07Z-K UL3386,25mm ² ,Blue,138A,LSZH Cable,VDE,UL
	25030638	Electronic Electric Cable,450V/750V,H07Z-K UL3386,25mm ² ,Black,138A,LSZH Cable,VDE,UL
between DCDU12B and Rectifier	25030428	Electronic Electric Cable,450V/750V,60227 IEC 02(RV),16mm ² ,Black,85A,CCC,CE
	25030430	Electronic Electric Cable,450V/750V,60227 IEC 02(RV),16mm ² ,Blue,85A,CCC,CE
Between RRU5502&RR5513 and DCDU16D-02	25033534	Electronic Electric Cable,600V,UL2586,2x7AWG,Black (2Cores: Blue,Black),D,Shielding Outdoor Cable,UL
Between RRU5502&RR5513 and DCDU16D-02 "more than 70m and need Connection Box"	25033535	Power Cable,600V,UL2586,2x5AWG,Black(2Cores:Blue,Black),D,Shielding Outdoor Cable,UL (Unit:meter)
Between RRU5909 and DCDU12B	25033327	Electronic Electric Cable,600V,UL2586,2x12AWG,Black(2Cores:Blue,Black),D,Shielding Outdoor Cable,UL
Between RRU5910 and DCDU12B	25033328	Electronic Electric Cable,600V,UL2586,2x10AWG,Black(2Cores:Blue,Black),D,Shielding Outdoor Cable,UL
Between BBU and DCDU16D-02	4152214	Power Cable,0.7m,Blue/Black,HDEPC,2*H07Z-K-4 ² BL+2*H07Z-K-4 ² B,BBU5900 Power
	4152227-005	Power Cable,2m,Blue/Black,HDEPC,2*H07Z-K-4 ² BL+2*H07Z-K-4 ² B,BBU5900 Power Cable,LSZH

Indoor cabinet MTS9604B Circuit Breaker Design

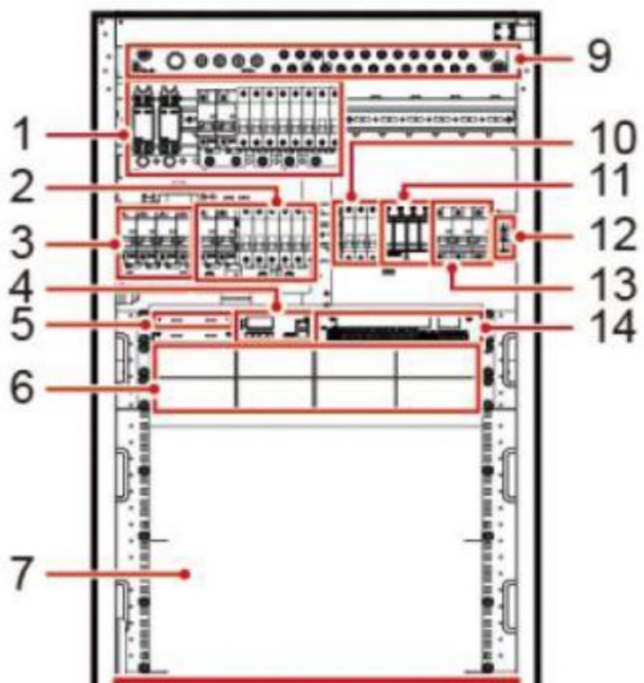

- (1) LLVD route (2) BLVD route (3) Battery route
- (4) Site monitoring unit SMU02C
- (5) Space for the communications expansion module
- (6) Space for rectifiers
- (7) Space for customer equipment
- (8) Space for lead-acid batteries (9) RTN + busbar
- (10) AC output circuit breaker
- (11) AC SPD (12) AC terminal N
- (13) AC input circuit breaker
- (14) User interface module UIM03F1

HUAWEI MTS9604B Breaker																	
LLVD										BLVD							
1	2	3	4	5	6	7	8	9	10	11	12	13	14	15	16	17	18
100A	100A	63A	63A	63A	63A	32A	32A	16A	16A	100A	100A	63A	63A	16A	16A	10A	10A
DUDU16D-02	DUDU16D-02	DCDU-12B	DCDU-12B	1*RRU5513(RRU5502)						RTN-1	RTN-2	RTN-1	RTN-2	ATN-1	ATN-2		

DCDU16D-02 Circuit Breaker Design Support (RRU5513,RRU5502)

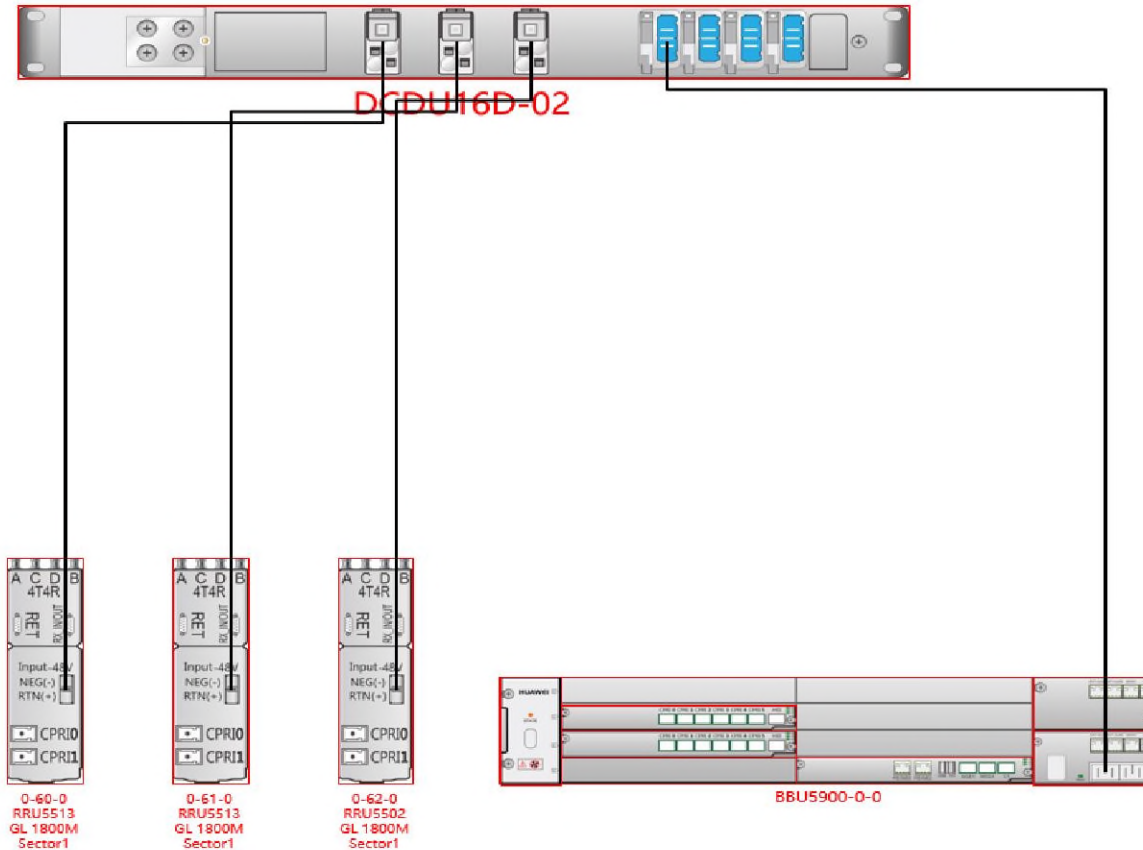

Description of work for RRU :

- Install 1*DCDU16D-02
- Connect 3*RRU5513 or 3*5502 on DCDU
- Connect 1*BBU 5900

DCDU-12B Circuit Breaker Design Support (RRU5910, RRU5909)

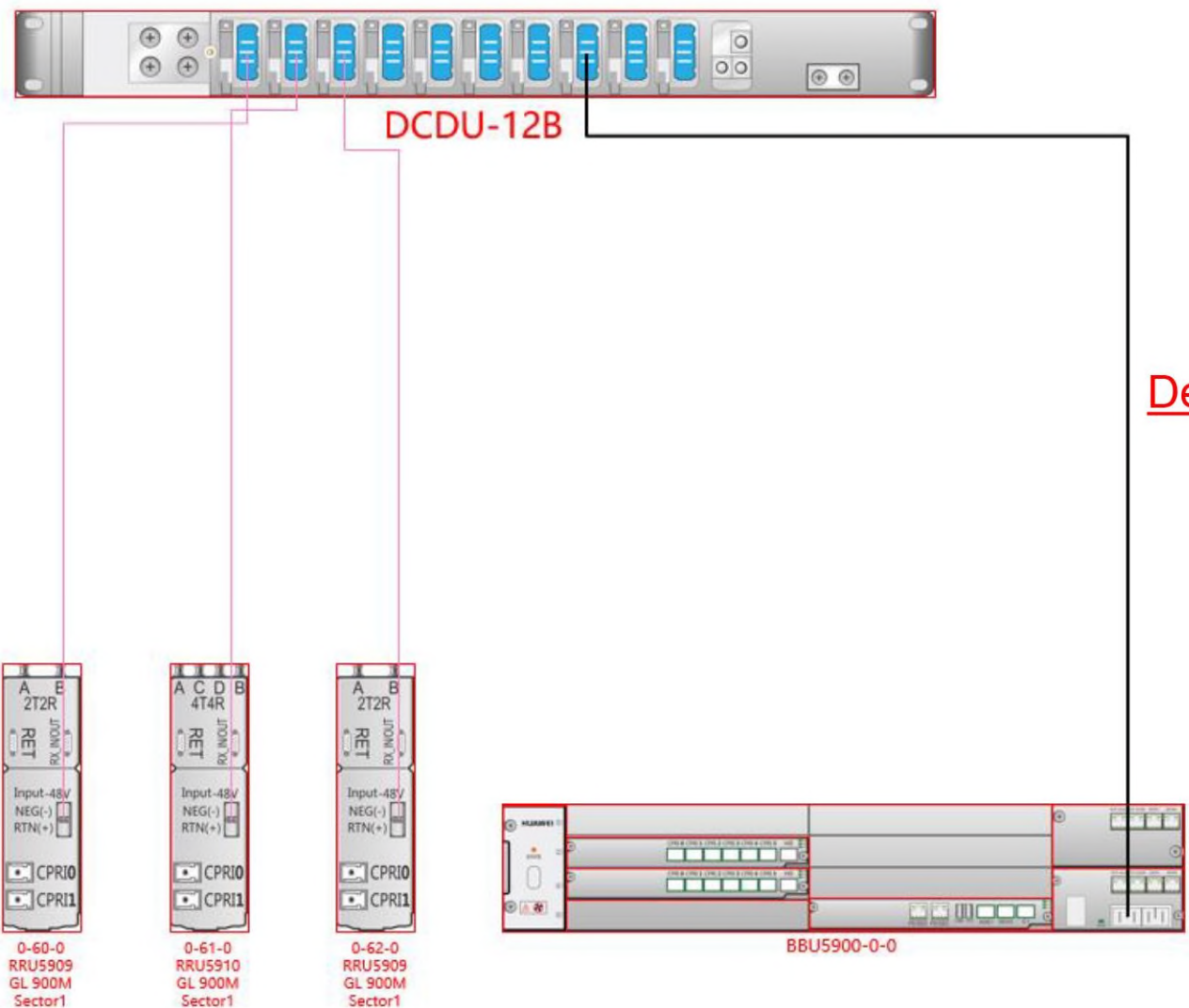

Description of work for RRU :

- Install 1*DCDU12B
- Connect 3*RRU5910 or 3*5909 on DCDU-12B
- Connect 1*BBU 5900



DCDU-12B/DCDU16D-02 Supported RRU Power Description

Part Number	Model	Description	DC Power Distribution Unit DCDU16D-02 (2122720)	DC Power Distribution Unit(12B) (2120731)
02311TBA	WD5M9E5909GB	RRU5909 for Multi-Mode 900MHz(2*60W)	/	Yes/ can support 6 PCS
02312XXF	WD5MBW5513C0	RRU5513 for Multi-mode 1800MHz~2100MHz (4T4R*2, 4*100W)	Yes/ can support 3 PCS	/
02313TEE	WD5M90059100	RRU5910 for Multi-Mode 900MHz(4*60W)	/	Yes/ can support 6 PCS
02312BSJ	WD5MBW5502GB	RRU5502 for Multi-mode 1800MHz~2100MHz (4T4R*2, 4*80W)	Yes/ can support 3 PCS	/

DCDU-12B Circuit Breaker Description



Base Station	Application Scenario	DC Output Port	Power-Consuming Equipment	Fuse Specifications
DBS3900	<ul style="list-style-type: none"> Power cabinet TMC11H (Ver.D) or TMC11H (Ver.E) in a DBS3900 DBS3900 where the BBU is installed on a wall, in a 19-inch rack, or in an IMB03 	LOAD0 to LOAD5	RRU	10x30 A ^b
		LOAD6 and LOAD7	Transmission equipment, BBU, or RRU ^a	
		LOAD8	Transmission equipment or RRU ^a	
		LOAD9	FAN 02D or FAN 02E	
BTS3900AL (Ver.A)	BTS3900AL (Ver.A) configured with RFUs and RRUs	LOAD0 to LOAD8	RRU 0 to RRU 8	10x30 A
BTS3900AL (Ver.A)	BTS3900AL (Ver.A) configured with RFUs and RRUs	LOAD9	Reserved	10x30 A
<ul style="list-style-type: none"> BTS3900A (Ver.D) BTS3900A (Ver.E) BTS3900 (Ver.D) BTS3900L (Ver.D) BTS3012AE (Ver.D_Z) BTS3012 (Ver.D_Z) 	<ul style="list-style-type: none"> RFC (Ver.D) in a BTS3900A (Ver.D) configured with RFUs and RRUs RFC (Ver.E) in a BTS3900A (Ver.E) configured with RFUs and RRUs Cabinet in a BTS3900 (Ver.D) configured with RFUs and RRUs Cabinet in a BTS3900L (Ver.D) configured with RFUs and RRUs Cabinet in a BTS3012AE (Ver.D_Z) configured with RFUs and RRUs Cabinet in a BTS3012 (Ver.D_Z) configured with RFUs and RRUs 	LOAD0 to LOAD8	RRU 0 to RRU 8	10x30 A
		LOAD9	Reserved	

a: When six or fewer RRUs are configured, connect the RRUs preferentially to power ports LOAD0 to LOAD5. Ports LOAD6 to LOAD8 only supply power to the seventh to ninth RRUs when more than six RRUs are configured.

b: The output current of one circuit cannot exceed 25 A.





DCDU16D-02 Circuit Breaker Description



DC Output Terminal	Power-Consuming Equipment	Circuit Breaker/Fuse Specifications
LOAD0 to LOAD2	RRU	3x50 A ^a
LOAD3 to LOAD6	Transmission equipment, BBU, or FAN	4x30 A ^b

a: Each power output is less than or equal to 50 A.

b: Each power output is less than or equal to 25 A, and the total power output is less than or equal to 60 A.

No.	Port and Terminal	Silkscreen	Connector and Cable	Description
(1)	DC input terminals	<ul style="list-style-type: none"> NEG(-) RTN(+) 	Two one-hole OT terminals (M6). One group of power cables with a maximum cross-sectional area of 35 mm ² (0.054 in. ²) or two groups of power cables with a maximum cross-sectional area of 25 mm ² (0.039 in. ²) are supported.	<ul style="list-style-type: none"> Negative power input terminal Positive power input terminal
(2)	Circuit breaker output ports ^a	LOAD0 to LOAD2	Bare wires. The supported cable cross-sectional area ranges from 6 mm ² to 16.7 mm ² (0.0093 in. ² to 0.026 in. ²).	For the specifications of DC outputs, see Table 3.
(3)	Fuse blocks ^b	LOAD3 to LOAD6	-	It controls the LOAD3 to LOAD6 ports, and therefore controls the power supply to modules such as BBUs, transmission equipment, and fan assemblies.
(4)	DC output ports	LOAD3 to LOAD6	EPC4 connectors ^c are used for the LOAD3 to LOAD6 ports. Figure 3 shows the exterior. The supported cable cross-sectional area ranges from 1.5 mm ² to 4 mm ² (0.0023 in. ² to 0.0062 in. ²).	For the specifications of DC outputs, see Table 3.
(5)	Spare fuse box	-	-	It contains two 30 A spare fuses.

a: The wiring terminals of circuit breakers must be connected to cables onsite.

b: The indicator on the fuse block indicates the status of the fuse. When the indicator is steady on, the fuse is faulty and must be replaced. When the indicator is steady off, the fuse is working properly.

c: EPC4 connectors must be connected to cables onsite.



External Alarm solution

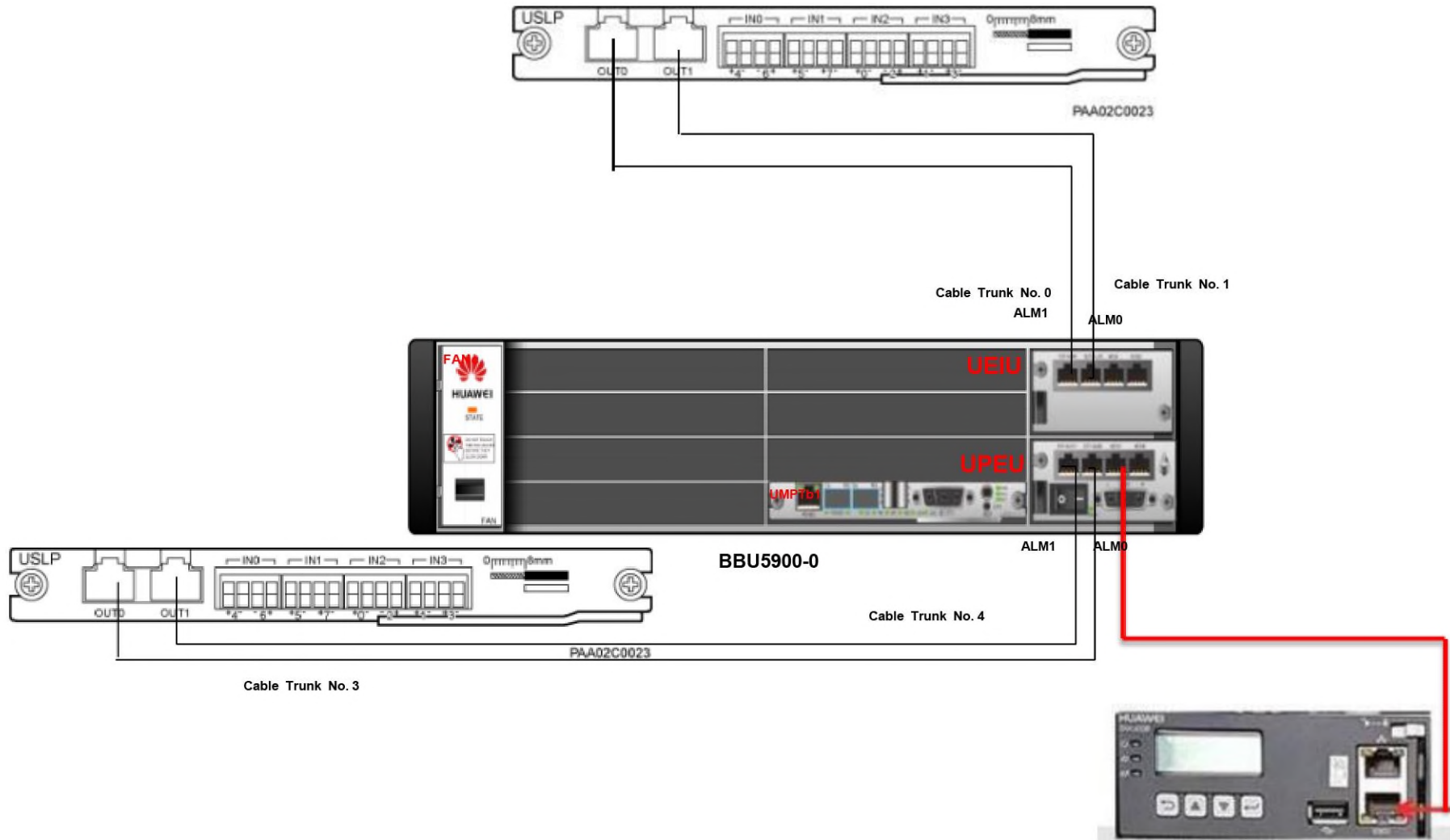



Huawei Solution for Alarm Reporting – UIM05B1 Hardware Description

UIM05B1

The UIM05B1 provides sensor ports, RS485 ports, and dry contact input and output ports to manage the interior environment of the power system and to report alarms.

Figure 1 Exterior of an UIM05B1

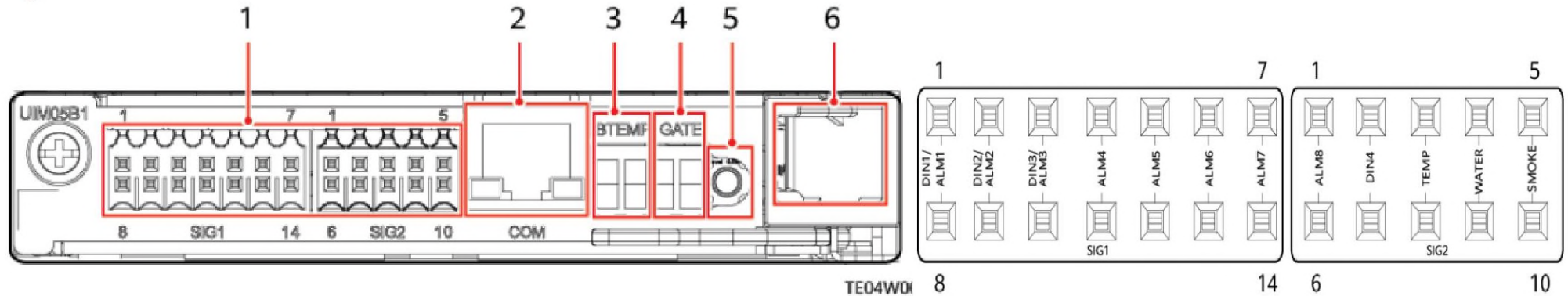

UIM05B1 Slot Assignment Rules

(1) Dry contact ports and sensor ports	(2) COM communications port	(3) Battery temperature sensor port
(4) Door status sensor port	(5) Battery switch	(6) Cable hole



Huawei Solution for Over Voltage Protection – SLPU

Hardware Description

SLPU

The signal lightning protection unit(SLPU), which has a case structure, is 19 inches wide and 1 U high.

Figure 1 Exterior of an SLPU

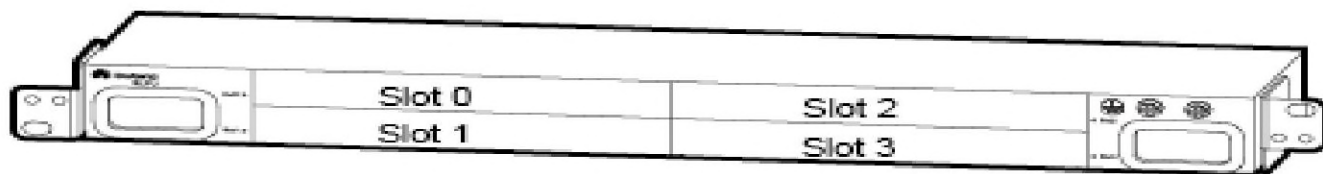

SLPU Slot Assignment Rules

Board	Optional or Mandatory	Maximum Quantity	Slot	Restriction
USLP	Optional	2	Slot 2 and slot 3	



Huawei Solution for Over Voltage Protection – USLP Hardware Description

USLP

A universal signal lightning protection unit (USLP) provides protection for dry contacts and can be installed inside the SLPU Slot 2 and 3 , We have two card USLP of each site.

The following figure shows the USLPc panel.

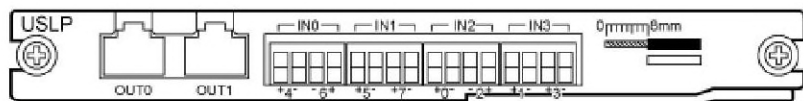

PAA02C0023

Port

The following table describes ports on the USLPc.

Table 1 Ports on the USLP2 or USLPc			
Silkscreen	Connector	Quantity of Ports	Description
IN0, IN1, IN2, and IN3	4-pin	4	Connect to customized alarm devices.
OUT0 and OUT1	RJ45 connector	2	Connects to the EXT-ALM port on the UPEU or UEIU in a cabinet.

Mapping between the pins in the IN and OUT ports inside the USLP

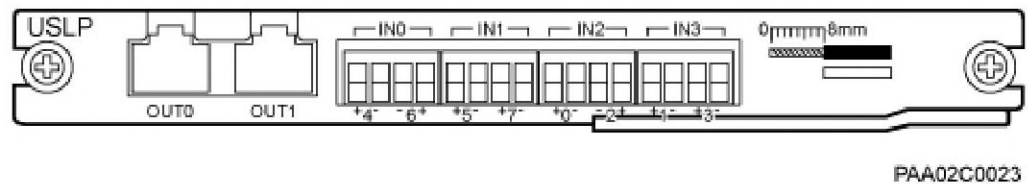

PAA02C0023

Figure 1 USLPc panel

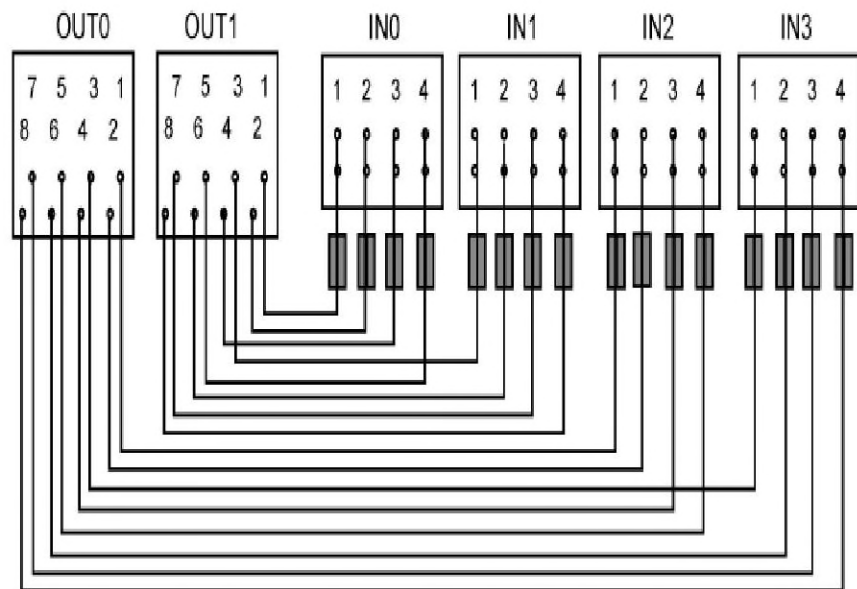

Figure 2 Mapping between IN & OUT Pins

Input Port		Output Port	
Silkscreen	Pin	Silkscreen	Pin
IN0	IN0.1	OUT1	OUT1.1
	IN0.2		OUT1.2
	IN0.3		OUT1.3
	IN0.4		OUT1.4
IN1	IN1.1		OUT1.5
	IN1.2		OUT1.6
	IN1.3		OUT1.7
	IN1.4		OUT1.8
IN2	IN2.1	OUT0	OUT0.1
	IN2.2		OUT0.2
	IN2.3		OUT0.3
	IN2.4		OUT0.4
IN3	IN3.1		OUT0.5
	IN3.2		OUT0.6
	IN3.3		OUT0.7
	IN3.4		OUT0.8

Table 1 Mapping between IN & OUT Pins



External Alarms Design in side Huawei Cabinets(Outdoor Site)

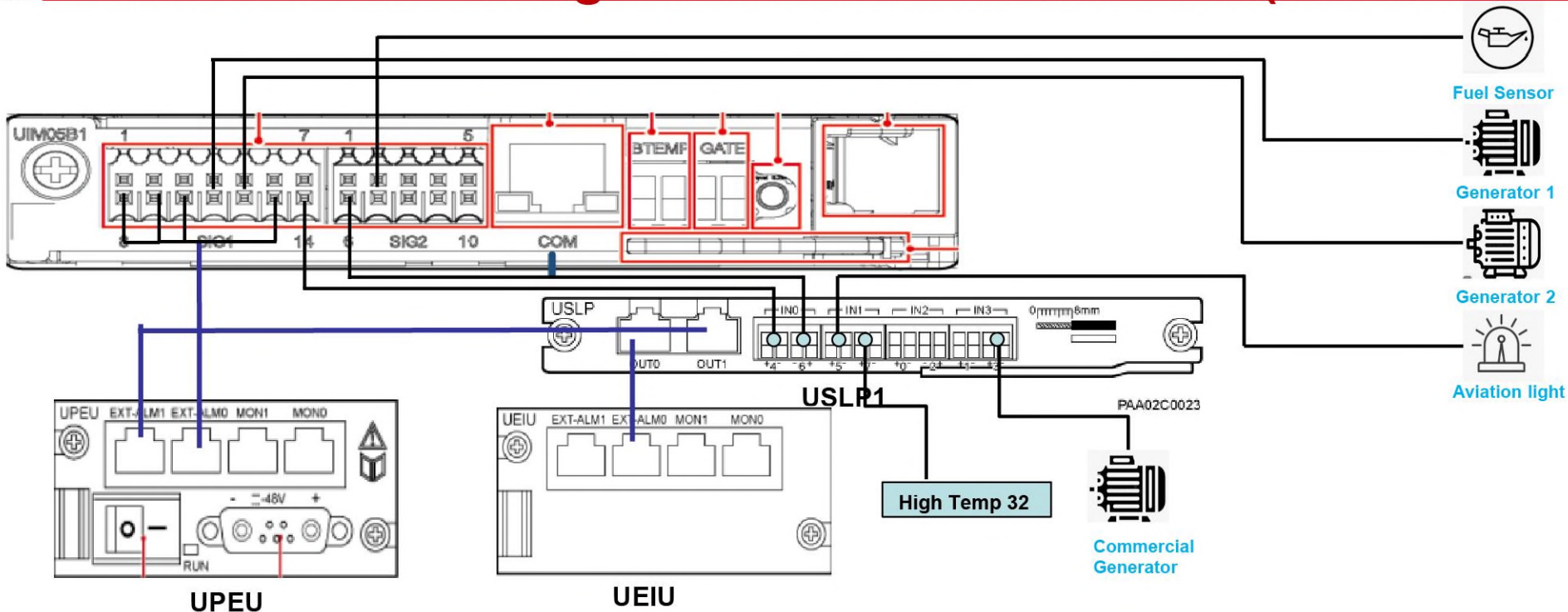

Signal Resource	Alarm Name	USLP	UIM Port OUT	USLP Port OUT	BBU Port	Signal Resource	Alarm Name	USLP	UIM Port OUT	USLP Port IN	USLP Port OUT	BBU Port	
UIM Board	Main failure	1	ALM1	N/A	UPEU EXT_ALM0	External Alarm	Low fuel level alarm	1	ALM7	IN0 (1,2)	OUT 1	UPEU EXT_ALM1	
	DC low voltage alarm	1	ALM2				Generator abnormal alarm	1	ALM8	IN0 (3,4)			
	Rectifier Module Fault	1	ALM3				Aviation light failure	1	External	IN1 (1,2)			
	High-temperature alarm	1	ALM6				High Temp 32	1	External	IN1 (3,4)			
							NA	1	External	IN2 (1,2)	OUT 0		UEIU EXT_ALM0
							NA	1	External	IN2 (3,4)			
						NA	1	External	IN3 (1,2)				
						Commercial Generator Fail	1	External	IN3 (3,4)				

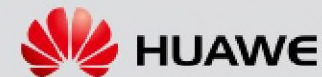



External Alarms Design in side Huawei Cabinets(Indoor Site)

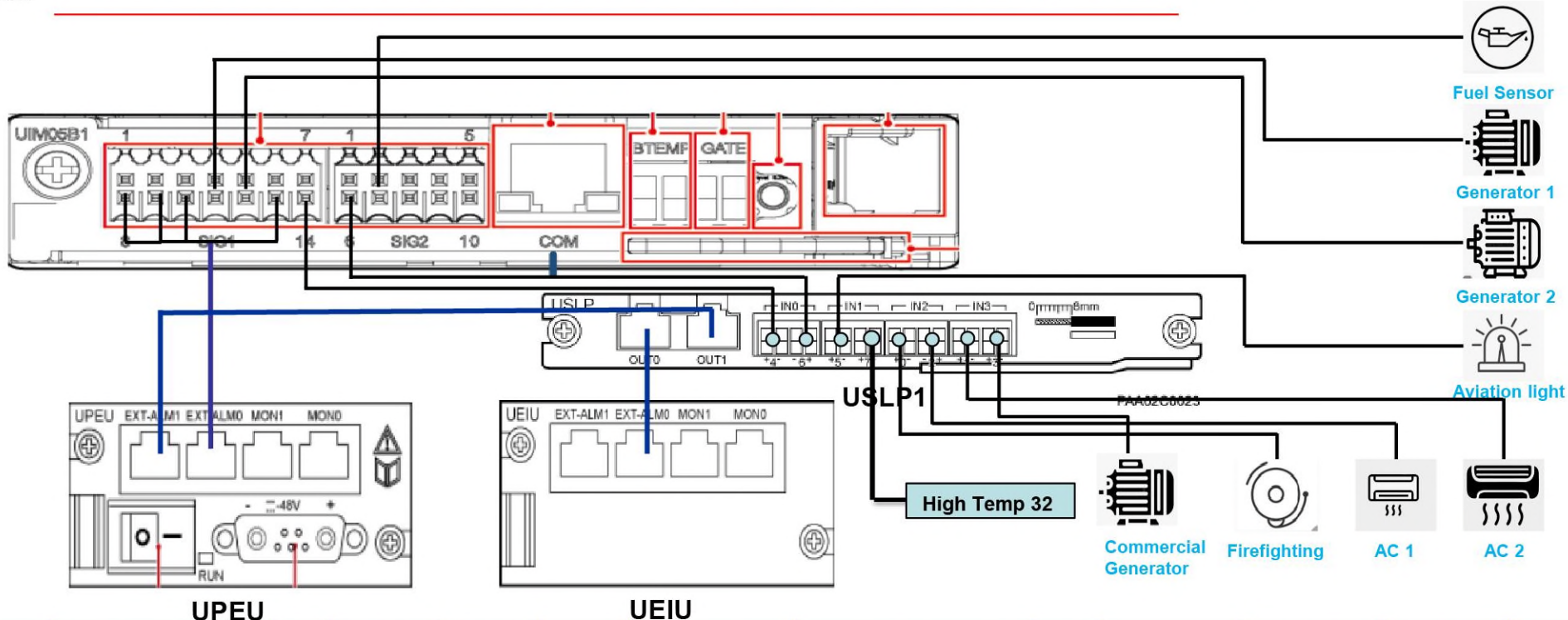

Signal Resource	Alarm Name	USLP	UIM Port OUT	USLP Port OUT	BBU Port	Signal Resource	Alarm Name	USLP	UIM Port OUT	USLP Port IN	USLP Port OUT	BBU Port
UIM Board	Main failure	1	ALM1	N/A	UPEU EXT_ALM0	External Alarm	Low fuel level alarm	1	ALM7	IN0 (1,2)	OUT 1	UPEU EXT_ALM1
	DC low voltage alarm	1	ALM2				Generator abnormal alarm	1	ALM8	IN0 (3,4)		
	Rectifier Module Fault	1	ALM3				Aviation light failure	1	External	IN1 (1,2)		
	High-temperature alarm	1	ALM6				High Temp 32	1	External	IN1 (3,4)		
							Firefighting alarm	1	External	IN2 (1,2)	OUT 0	UEIU EXT_ALM0
							Air condition failure 1	1	External	IN2 (3,4)		
							Air condition failure 2	1	External	IN3 (1,2)		
							Commercial Generator Fail	1	External	IN3 (3,4)		

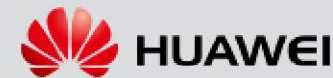



In Case TR Rectifier cabinet available for Indoor sites

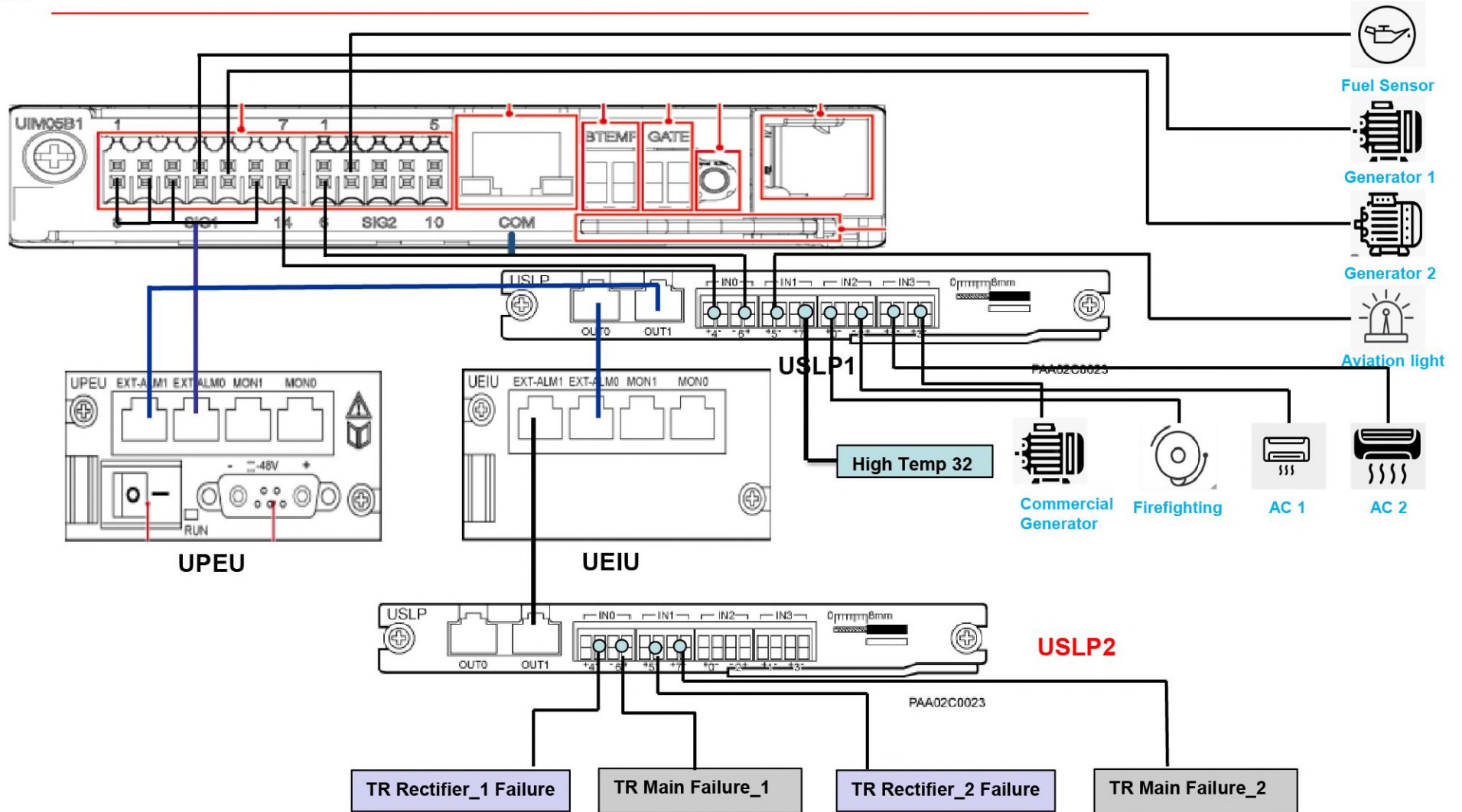

Cabinet Space (19 Unit in Huawei Cabinet to install Equipment)

Cabinet Space (19 Unit in our cabinet)					
Item Code	Item Model	Item Description	Unit	Total Requirement Unit	Unit
02311VFF	WD2M0BBU5900	BBU5900 Box	2U	Wireless	8U
2122720	WD2EDCDU16D2	DC Power Distribution Unit DCDU16D-02	1U		
2120731	TD1MDCDU12B0	DC Power Distribution Unit	1U		
2358793	GM5M0MSLPU00	Monitoring Signal Lightning Protection Unit (1~16 Boolean Alarm)	1U		
		Space between wireless Board	3U		
		ATN910D-A	1U	ATN	4U
		ODF-48 core	1U		
		Space between Core Board	2U		
02313PLK		OptiX RTN 980	5U	Transmission	
02311DEN		OptiX RTN 950A	2U		
02312CYT		OptiX RTN 905	1U		
		Customer Devices		waiting IP team confirmation	



Equipment arrangement inside cabinet

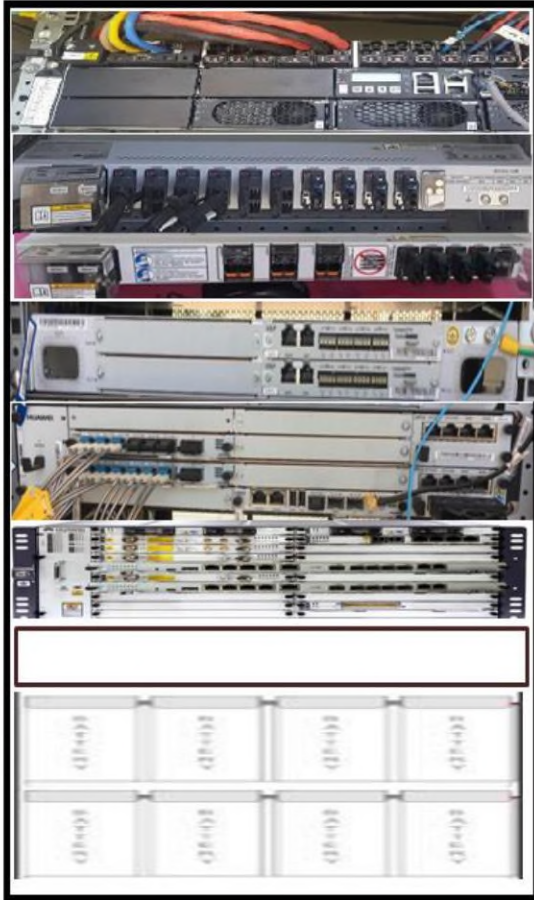

- ← DCDU 12-B
- ← DCDU 16-D
- ← SLPU
- ← BBU5900
- ← RTN/ATN MW
- ← Expansion device Slot
- ← Battery Rack

Power System
DCDU-12B
DCDU-16D
SLPU
BBU
RTN
Expansion Device Slot
Battery Rack

Note: Keep 2 Hole space between each Module device Installation



BBU5900-Transmission connection Diagram

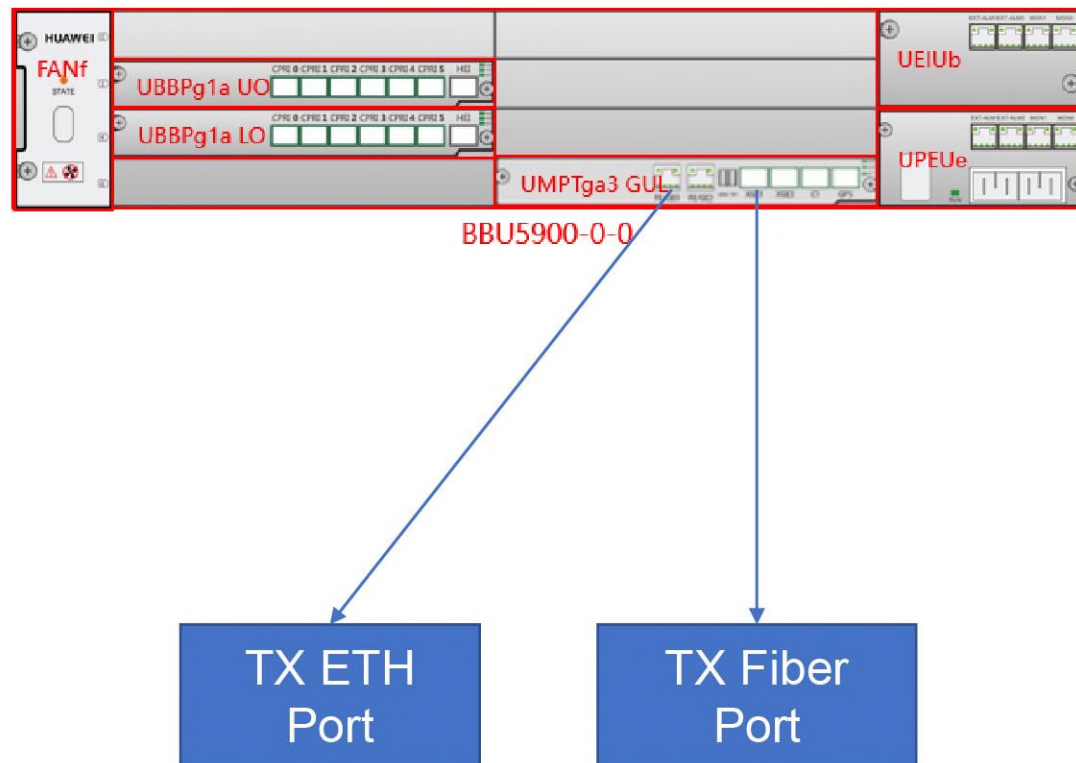



RTN905 to NodeB(BBU) connectivity in Case of RTN 905 (Port of RTN not Confirmed)

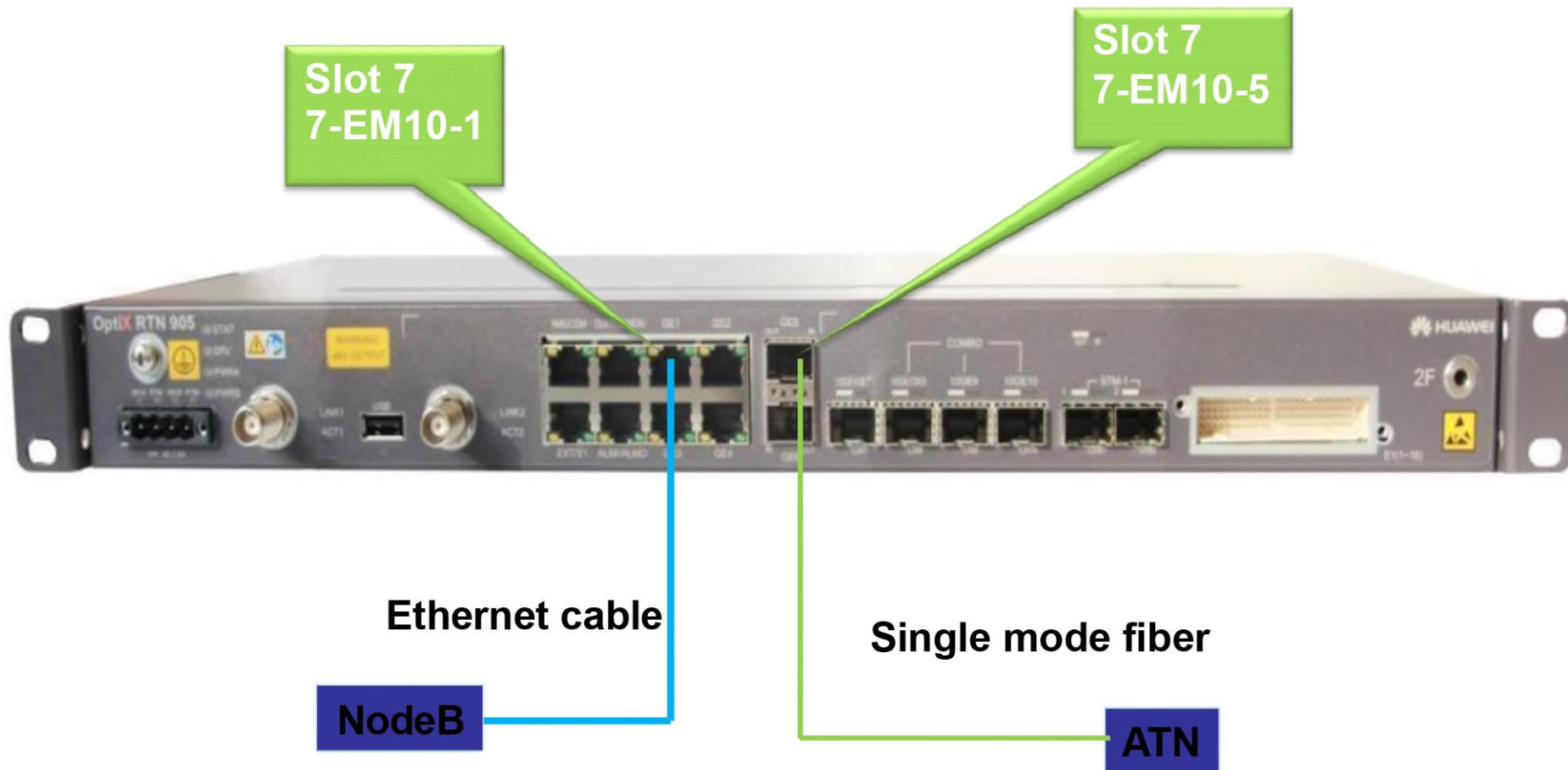



NodeB(BBU) Connectivity in Case of ATN (Port not Confirmed)





RTN980 to NodeB(BBU) connectivity Port Not Confirmed

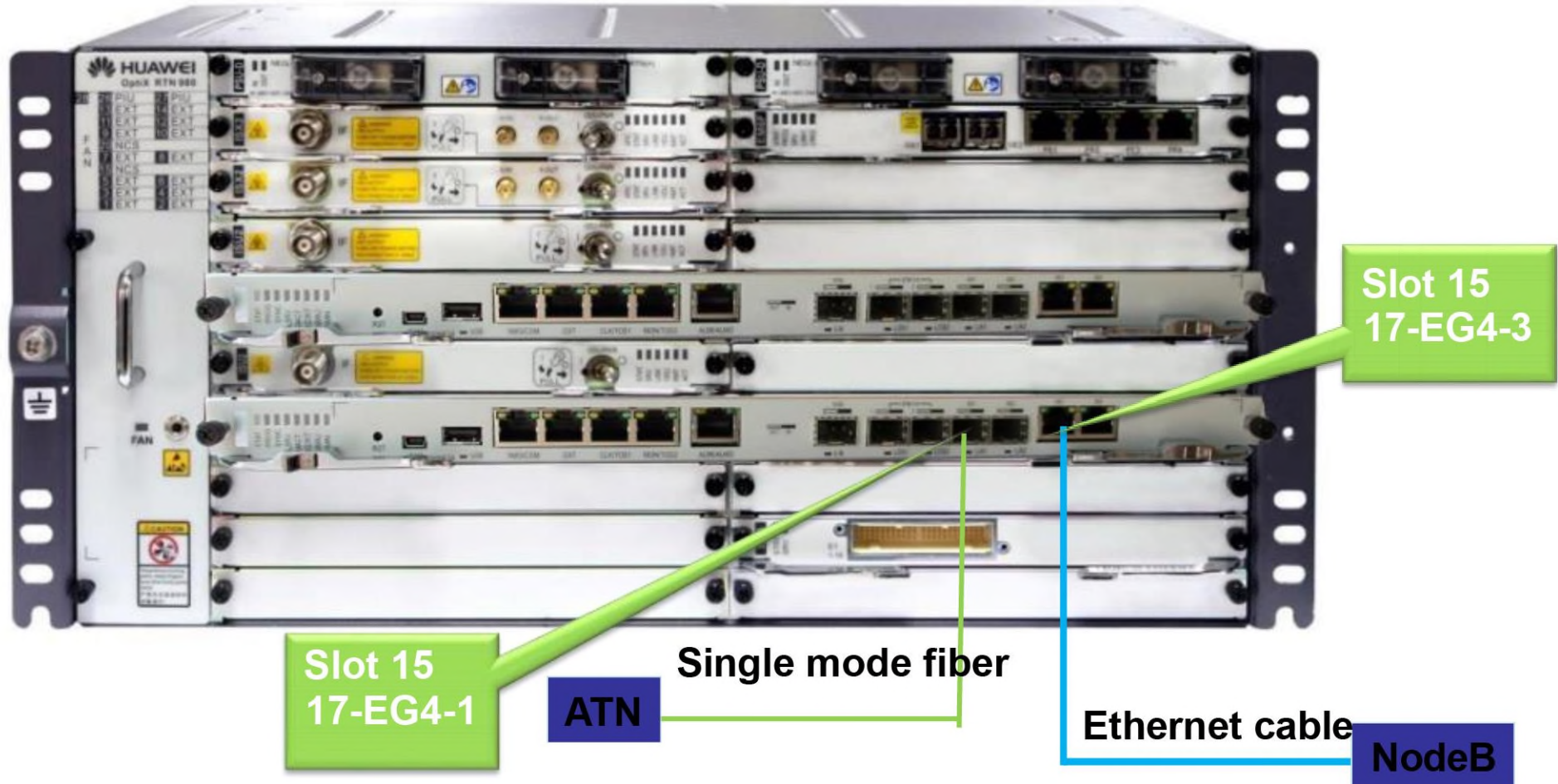



RTN910 to NodeB(BBU) connectivity Port Not Confirmed



**NodeB
Ethernet cable
port n confirmed**





GPS Antenna installation with Water proof & label and Ground

Arrester install inside cabinet and GPS antenna installed in free space area

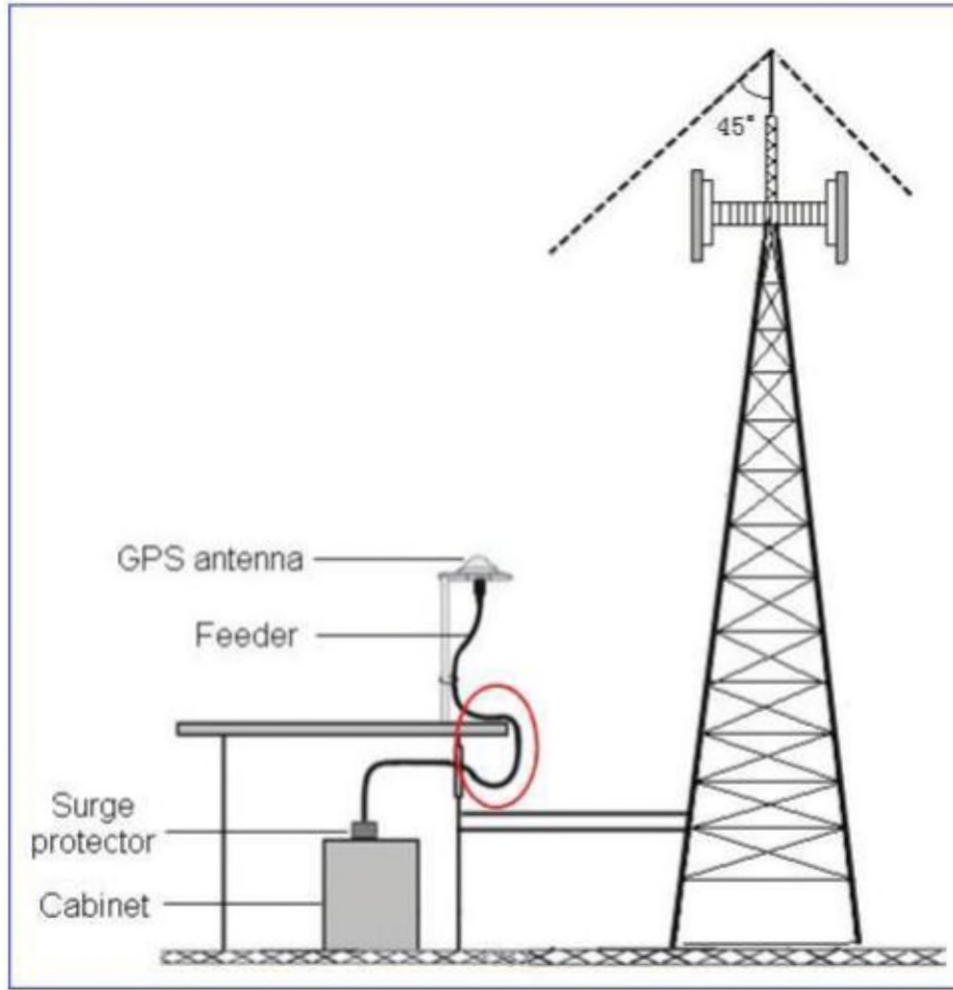

Risk: Some sites are without sunshade shelter need to install GPS on bottom on tower leg required to add more coaxial cable length



Cabinet Quality standard key points

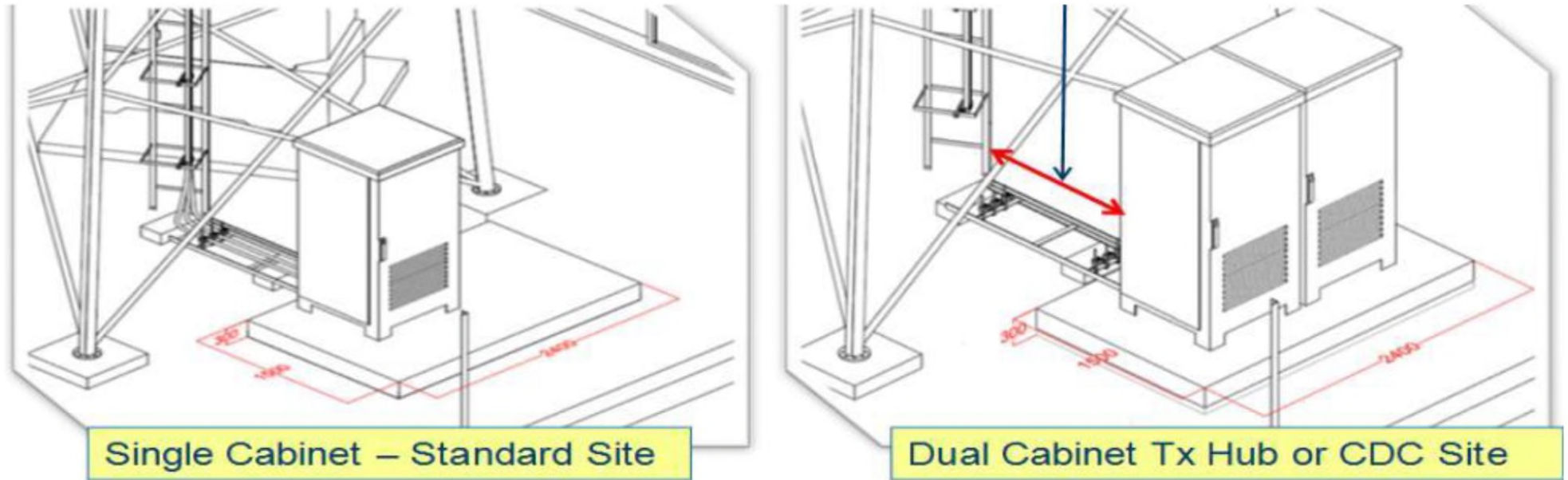

Key Points:

- I. At green field sites, cabinets should be installed on a concrete slab and this slab should be big enough to accommodate 2 cabinets to allow for future expansion;
- II. A key consideration in the location of the cabinet is to install the cabinet as close as possible to the vertical feeder runway on the tower so as to minimize the volt drop to the RRU's



Loop Standard with labeling

- Fiber loop will fix on the try Box near cabinet as below photo.
- RRU DC cable without Loop .
- Put loop inside Box and fixed by cable ties and label it .
- Box Location 1-2M near to cabinet location .





Cable entrance of Outdoor cabinet

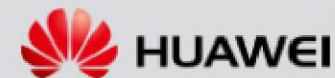
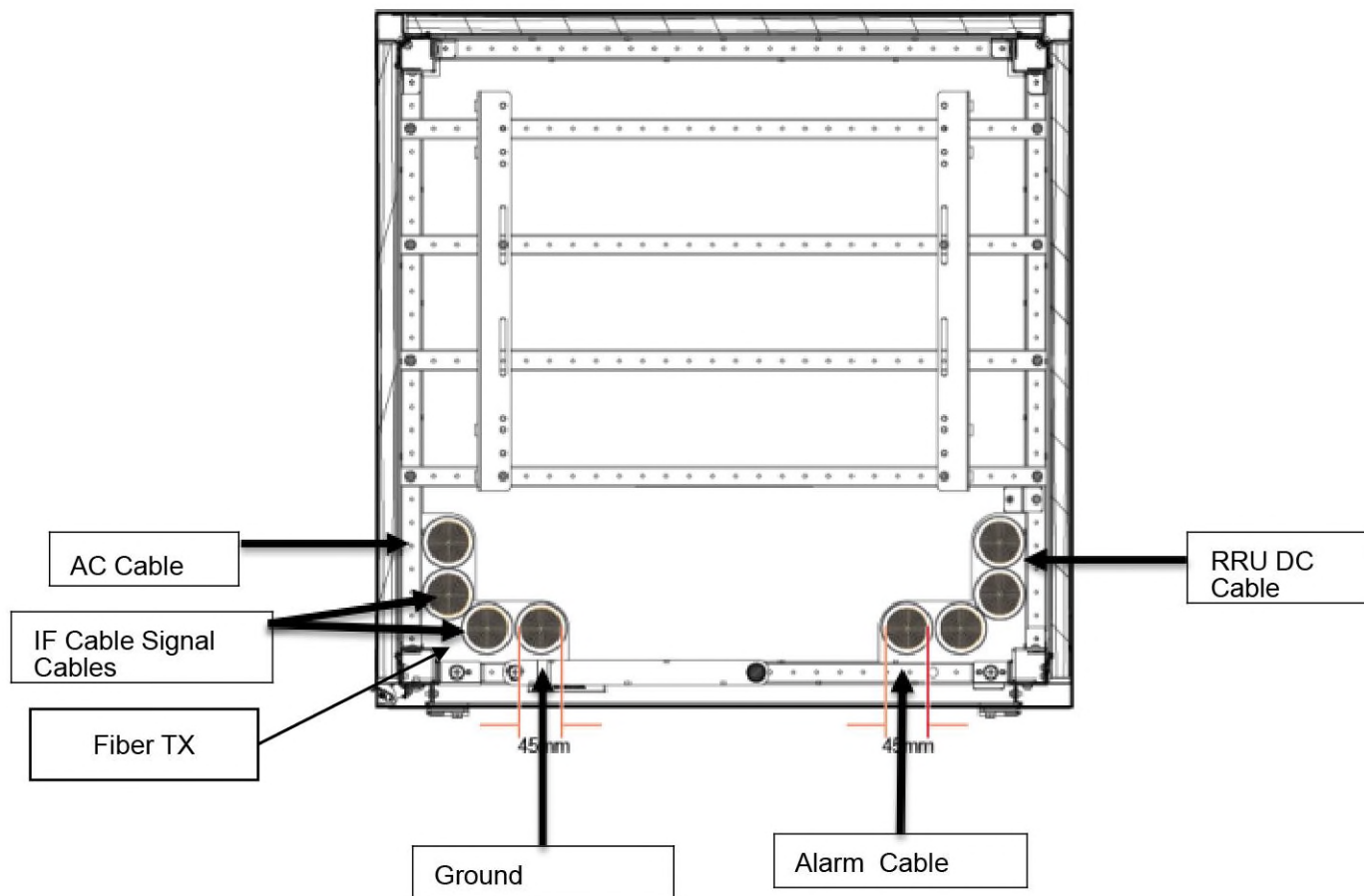



Cable entrance of Indoor cabinet

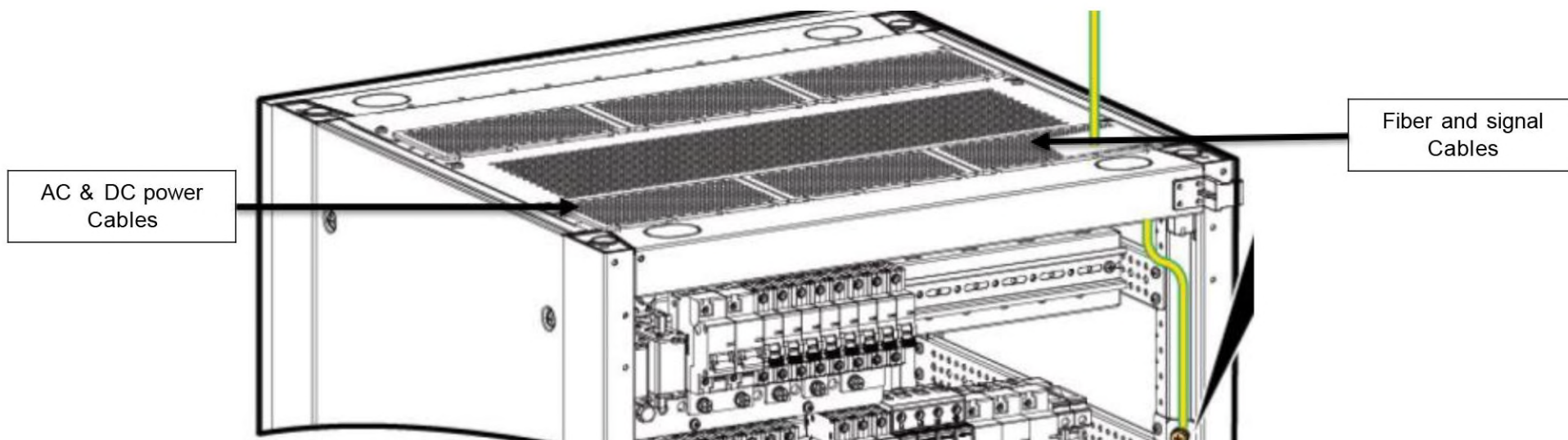



Cable Ladder & Cable Tray

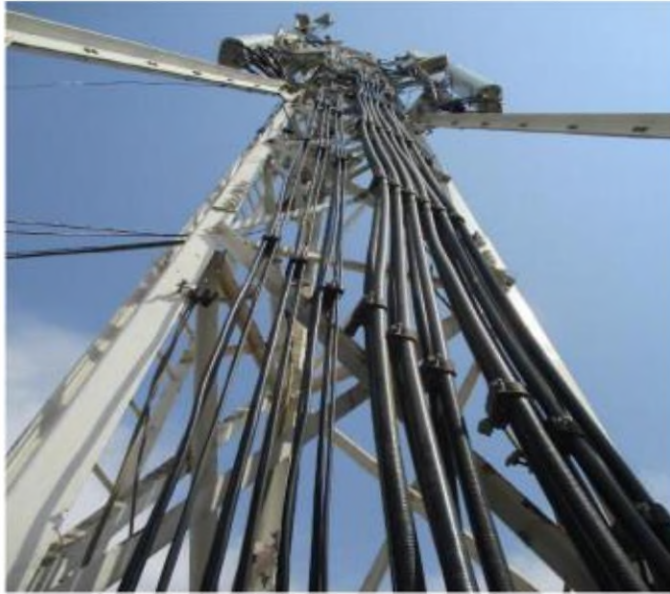

- 1- All the CPRI cables and RRU DC cable and IF cable should be arranged inside cable tray as well from the mini shelter to the tower.
- 2- keep with space between IF, DC And CPRI
- 3- All cables are labeled
- 4- 1.5 Meter Between each two Clamp.
- 5- Clamp must be per_Sector.



Waterproof for RF Jumper Cable

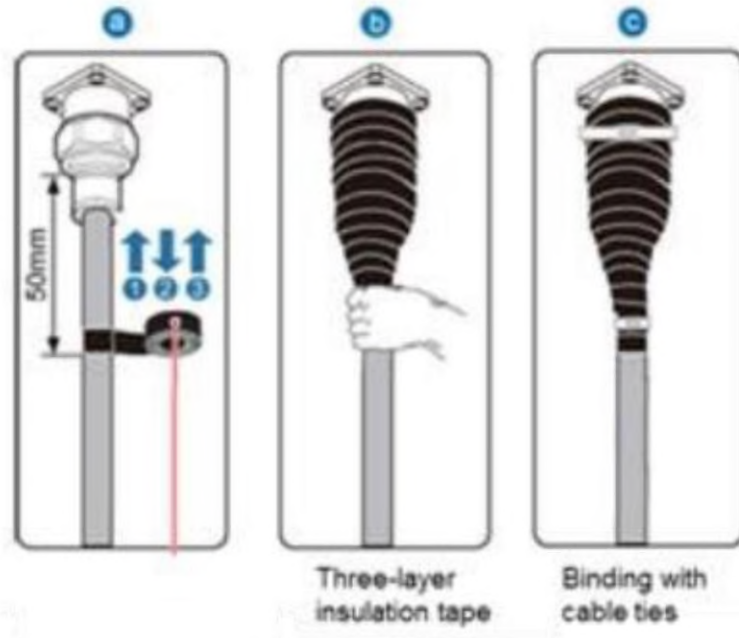

Three layers of insulation tape and cable ties

- A. Wrap three layers of PVC insulation tape. Start the wrapping at a position 30 mm (1.18 in.) away below the bottom of the waterproof tape to the top of the connector, first from bottom up, then from top down, and finally from bottom up. Cut off the redundant tape after three layers are wrapped. Wrap each layer of tape around the connector tightly.**
- B. start binding cable ties to the cable at a position 3 mm (0.12 in.) to 5 mm (0.2 in.) away from one end of the PVC insulation tape**



Site cable label description

➤ Color Ring Label Standard

Sectors	Position	Color ring	Color ring Triple band			Remark
		Single Band	900 Band	1800 Band	2100 Band	
1	Near Antenna and Inside HUAWEI Cabinet	1 Red	1 Red	2 Red	3 Red	Each of color ring keep 10mm distance
2		1 Yellow	1 Yellow	2 Yellow	3 Yellow	
3		1 Blue	1 Blue	2 Blue	3 Blue	
4		1 White	1 White	2 White	3 White	

Note :

- Sector 1 :Red color ,Sector 2 :Yellow color , Sector 3 : Blue color, Sector 4 : White
- site have single band :label by one ring only .
- Dual band label 900 band by one ring only and second band label by two rings (1800 or 2100)
- Triple band label 900 band by one ring only ,1800 band label by two rings ,2100 band label by two rings
- Key Points Different color ring descript different sector; Red/Yellow/Blue/White color ring descript Sector1/2/3/4



Site cable yellow label description

➤ Fiber & DC cable Label standard

Label Name	Tripe band Label place
PWR RRU 0	RRU DC power cable S1 900 band
PWR RRU 1	RRU DC power cable S2 900 band
PWR RRU 2	RRU DC power cable S3 900 band
PWR RRU 3	RRU DC power cable S1 1800 band
PWR RRU 4	RRU DC power cable S2 1800 band
PWR RRU 5	RRU DC power cable S3 1800 band
PWR RRU 6	RRU DC power cable S1 2100 band
PWR RRU 7	RRU DC power cable S2 2100 band
PWR RRU 8	RRU DC power cable S3 2100 band
CPRI 0	RRU fiber cable S1 900 band
CPRI 1	RRU fiber cable S2 900 band
CPRI 2	RRU fiber cable S3 900 band
CPRI 3	RRU fiber cable S1 1800 band
CPRI 4	RRU fiber cable S2 1800 band
CPRI 5	RRU fiber cable S3 1800 band
CPRI 6	RRU fiber cable S1 2100 band
CPRI 7	RRU fiber cable S2 2100 band
CPRI 8	RRU fiber cable S3 2100 band

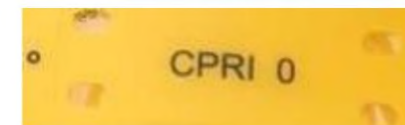

Label Example



Site cable label description : RF System Label Standard

Received by NSI/PA/RA Registration Unit 06/05/2024 8:12:33 PM



Sector Number	RRU Type	Label Name	Tripe band Label place	Band
S1	Low Band (RRU5910/RRU5909)	ANT_0A	RRU S1 port A 900 band	900
		ANT_0B	RRU S1 port B 900 band	
		ANT_0C	RRU S1 port C 900 band	
		ANT_0D	RRU S1 port D 900 band	
	High Band (RRU5513/RRU5502)	ANT_1A	RRU S1 port A 1800/2100 band	1800/2100
		ANT_1B	RRU S1 port B 1800/2100 band	
		ANT_1C	RRU S1 port C 1800/2100 band	
		ANT_1D	RRU S1 port D 1800/2100 band	
S2	Low Band (RRU5910/RRU5909)	ANT_2A	RRU S2 port A 900 band	900
		ANT_2B	RRU S2 port B 900 band	
		ANT_2C	RRU S2 port C 900 band	
		ANT_2D	RRU S2 port D 900 band	
	High Band (RRU5513/RRU5502)	ANT_3A	RRU S2 port A 1800/2100 band	1800/2100
		ANT_3B	RRU S2 port B 1800/2100 band	
		ANT_3C	RRU S2 port C 1800/2100 band	
		ANT_3D	RRU S2 port D 1800/2100 band	
S3	Low Band (RRU5910/RRU5909)	ANT_4A	RRU S3 port A 900 band	900
		ANT_4B	RRU S3 port B 900 band	
		ANT_4C	RRU S3 port C 900 band	
		ANT_4D	RRU S3 port D 900 band	
	High Band (RRU5513/RRU5502)	ANT_5A	RRU S3 port A 1800/2100 band	1800/2100
		ANT_5B	RRU S3 port B 1800/2100 band	
		ANT_5C	RRU S3 port C 1800/2100 band	
		ANT_5D	RRU S3 port D 1800/2100 band	
S4	Low Band (RRU5910/RRU5909)	ANT_0E	RRU S4 port A 900 band	900
		ANT_0F	RRU S4 port B 900 band	
		ANT_0G	RRU S4 port C 900 band	
		ANT_0H	RRU S4 port D 900 band	
	High Band (RRU5513/RRU5502)	ANT_1E	RRU S4 port A 1800/2100 band	1800/2100
		ANT_1F	RRU S4 port B 1800/2100 band	
		ANT_1G	RRU S4 port C 1800/2100 band	
		ANT_1H	RRU S4 port D 1800/2100 band	
AISG-RET	AISG (E-tilt)	AISG RRU 0	AISG (E-tilt) cable S1 900 band	AISG_900
		AISG RRU 1	AISG (E-tilt) cable S2 900 band	
		AISG RRU 2	AISG (E-tilt) cable S3 900 band	
		AISG RRU 3	AISG (E-tilt) cable S4 900 band	

Received by NSI/PA/RA Registration Unit 06/05/2024 8:12:33 PM



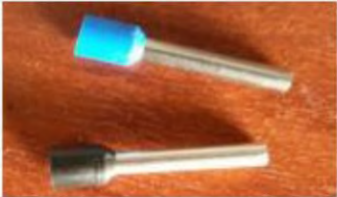

Power/Grounding Cable Connection Solution

PGND (From RRU to Mini bus bar)	16mm ²	Mini bus bar (In site operation)	
AC Power cable (From HUAWEI Mini-shelter power system to ACDB)	16mm ²	HUAWEI Mini-shelter and ACDB(On Site Operation)	
DC Power (BBU DC Power cable, from BBU to HUAWEI Mini-shelter power system)	3.5mm ²	HUAWEI Mini-shelter (On Site Operation)	
DC Power (IDU DC Power cable, from BBU to HUAWEI Mini-shelter power system)	3.5mm ²	HUAWEI Mini-shelter (On Site Operation)	



RRU Jumper with Label & Water Proof and Jumper cable installation at least the curve not less than 45 degree and should be looped and follow cable installation standard



AISG Cable Connection

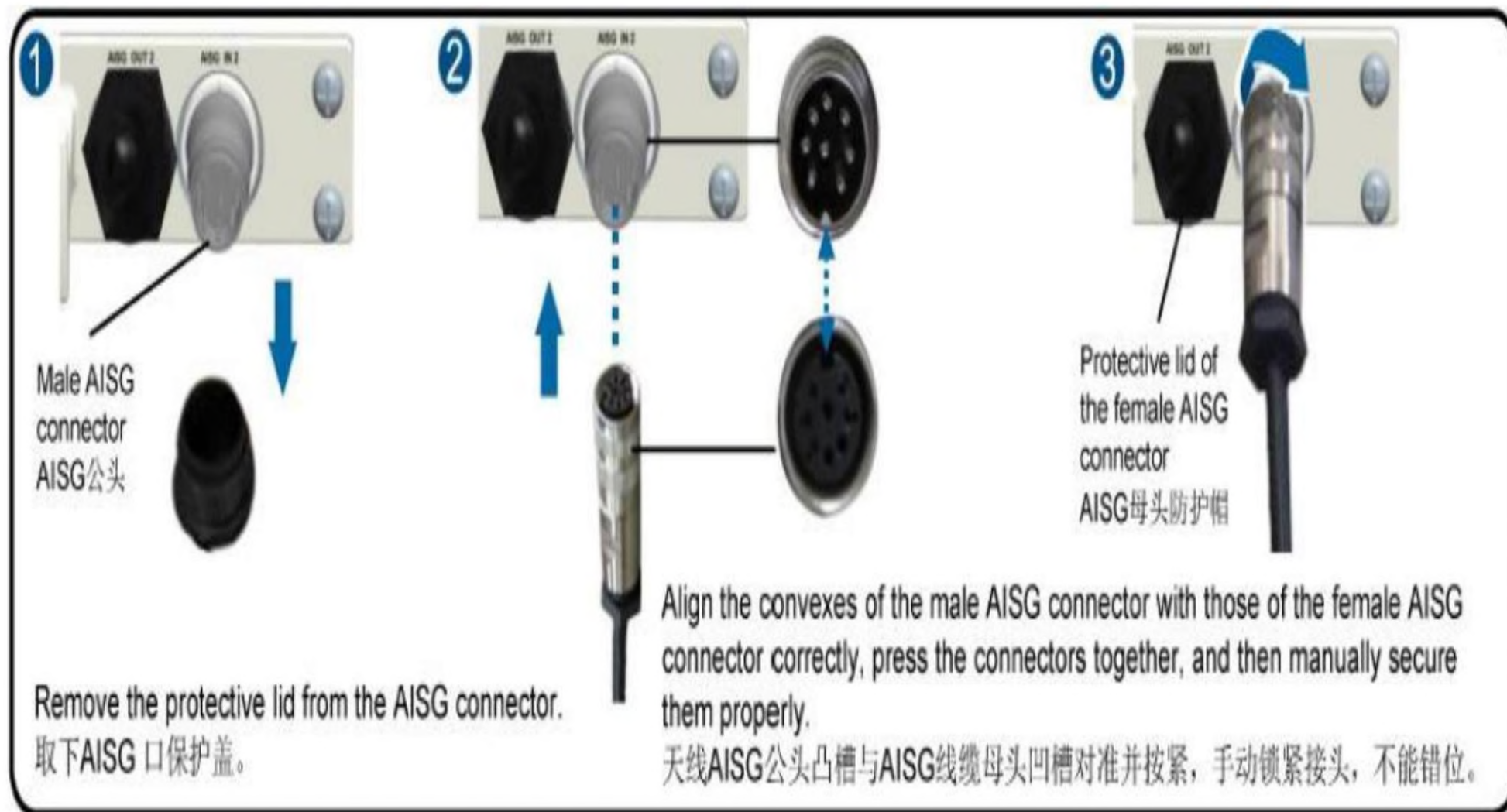

Note : for duel band connect AISG cables to 900 RRUs.



AISG Cable with Water proof & Label



Note :AISG cable loop fix on Antenna Mount



Power/Grounding Cable Connection Solution





Grounding – Mini Bus Bar Near Antenna



Key Points:

- 1. Each RRU connect one PGND cable to rooftop BasBar**
- 2. We can use the old Bus Bar if have enough hole or install new Bus Bar if no space . All of grounding cable should be use terminal**
- 3. we will install two ground cables in one BusBar hole but in 2 faces of busbar**



Connect the RRU Ground cable to Bas bar on Tower





RRU DC Power Grounding

➤ RRU side

A tool-less female connector (pressfit type) needs to be added to one end of the power cable on site. A terminal needs to be added to the other end based on the port on the power supply equipment. [Figure 1](#) shows an RRU DC power cable

Figure 1 Installing an RRU power cable

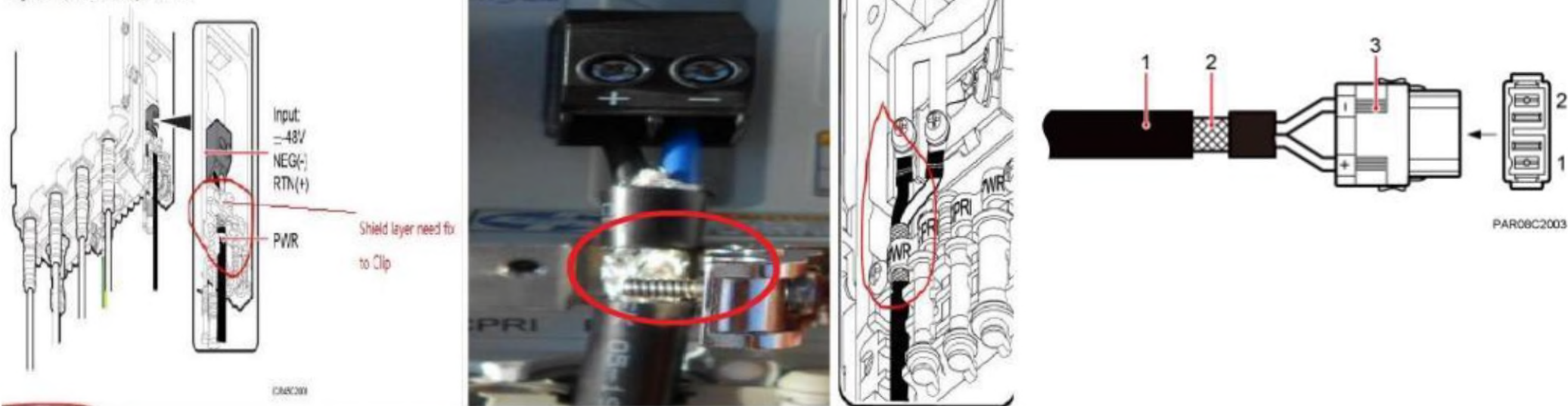

(1) -48 V DC power cable

(2) Shield layer

(3) Tool-less female EPC4 connector (pressfit type)



RRU DC Power Grounding

➤ Cabinet Side

Route the RRU power cable from the RRU side to the power equipment side through the feeder window. Install a ground clip near the feeder window outside the equipment room, and connect the PGND cable on the ground clip to the external ground bar. The procedure for installing a ground clip is as follows:

1. Use a wire stripper to strip 63 mm (2.48 in.) long jacket off the power cable to expose the shield layer.

Figure 1 Stripping the jacket off a power cable

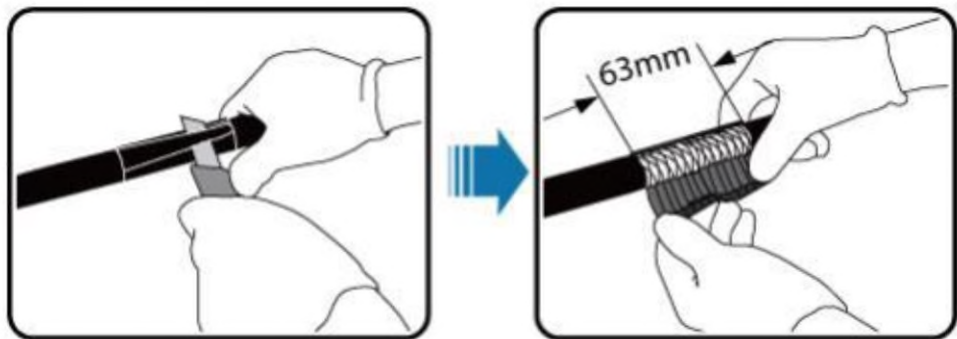

CMR06C2001



RRU DC Power Grounding

2. Wrap the copper sheet of the ground clip around the shield layer of the power cable, and use cable ties to bind them tightly. Then trim off surplus part from the heads of the cable ties without leaving any sharp edge.

Figure 2 Wrapping and tying the copper sheet of the ground clip

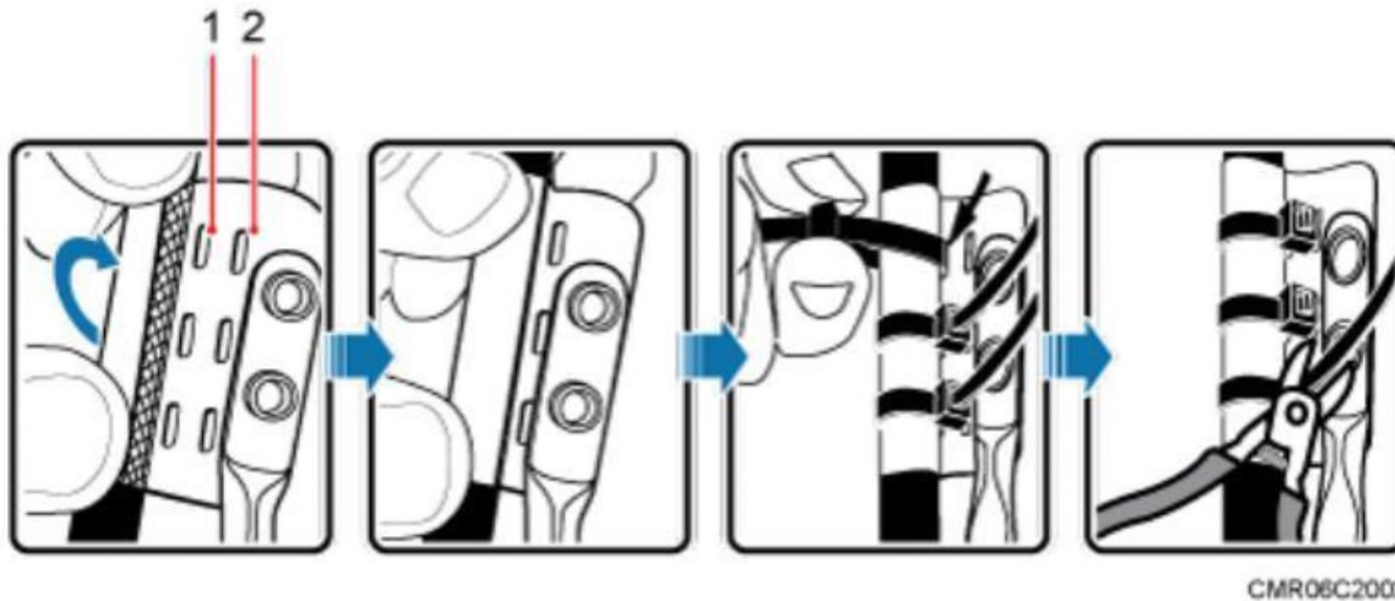

(1) Hole for an RRU power cable tie (12 AWG/4 mm² [0.006 in.²])

(2) Hole for an RRU power cable tie (N 6 mm² [0.009 in.²])



RRU DC Power Grounding

3. Wrap three layers of waterproof tape and three layers of insulation tape around the ground clip.

Figure 3 Wrapping the waterproof tape and insulation tape

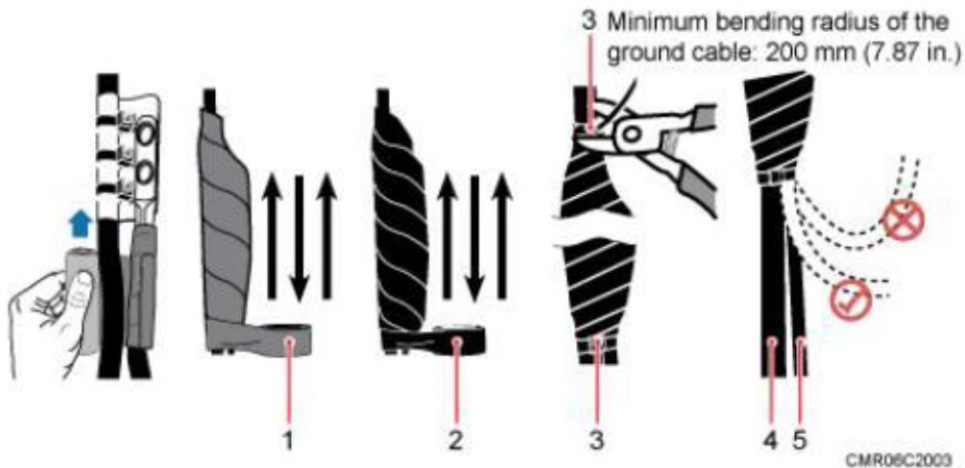

(1) Waterproof tape	(2) Insulation tape	(3) Cable tie
(4) Power cable	(5) PGND cable	-

Note :RRU DC power cable should be Earthed from both Side Cabinet and RRU



RF System Installation Standard

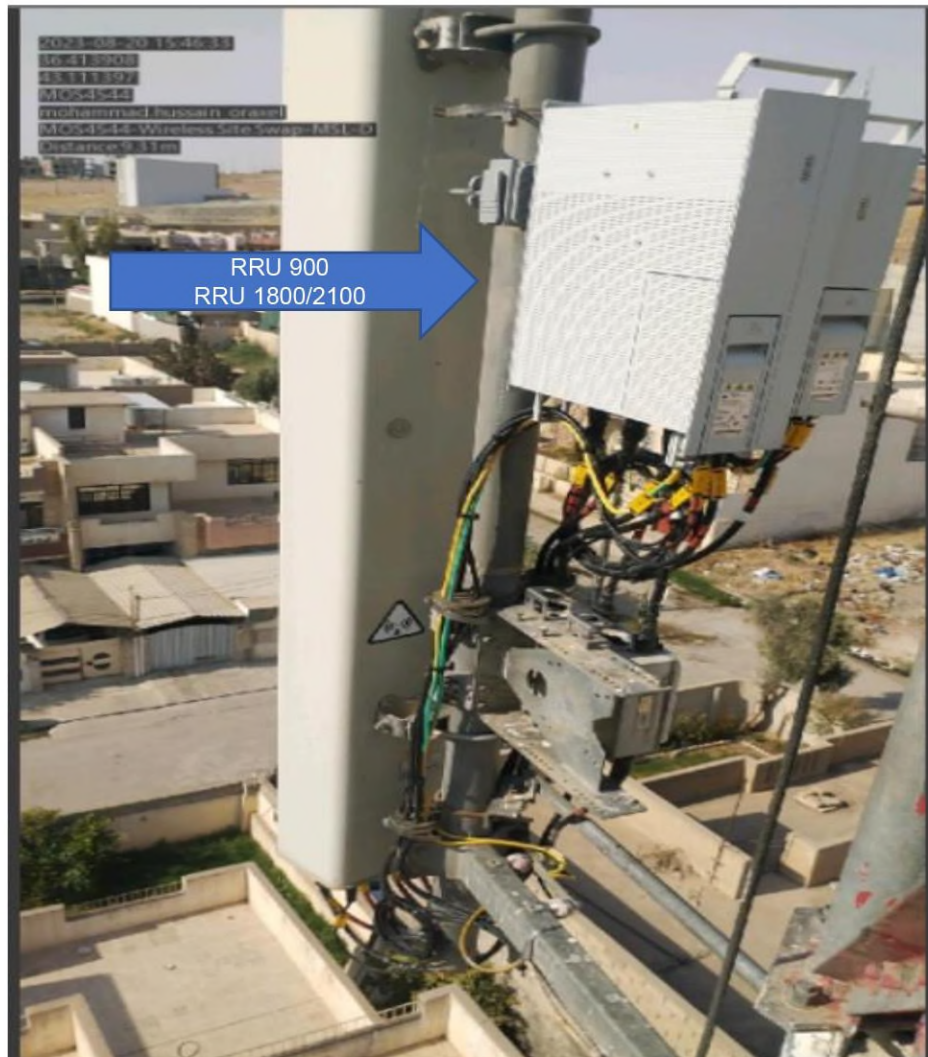



Telecom Quality standard key points

- RF cable will used 3 M for each sectors .
- Put labels and colored tape in all cables .
- Any cross is not acceptable .
- All the equipment's should be earthed .
- Installation of Terminals and antenna (RF)
- ALL Jumpers, are well waterproofed.
- The vacant RRU ports are securely covered.
- The vacant RF ports of antenna are waterproofed.
- Need to connected AISG Cable between each RRU & Antenna
- Need to connected all Port between RRU & Antenna
- Used Boot less for A.C power connection and ground cable connection
- Fiber optical loop fixed inside the box near cabinet.



Clean Site





(Close the Door & put all the rubbish outside)



Get Confirmation from NOC center that all service running well and no alarm before leave

Thanks

WWW.Huawei.Com



MAKE it
POSSIBLE